



RUIAN BOBA

PISTON CO.,LTD.

瑞安市博大活塞有限公司

中国内燃机工业协会会员单位 / 产品经国家内燃机质量监督检测中心检测合格



<http://www.bdpiston.com>
E-mail: info@bdpiston.com

• <http://www.bdpiston.com>
E-mail: info@bdpiston.com

以诚信、信誉、公平、公正的原则经营企业
our enterprise business principle is honesty,
and credibility and fairness and justice.

BODA  **活塞**
PISTON
瑞安市博大活塞有限公司



企业简介

BRIEF INTRODUCTION

瑞安市博大活塞有限公司，是一家专业生产汽车活塞的企业。公司位于〈中国汽摩配之都〉浙江省瑞安市。生产、生活环境优良，水、陆、空交通便利。

公司占地 2100 平方米，固定资产 800 万元，年生产各种汽车活塞 65 万只，企业内部实行标准化、量化、制度化、规范化管理；拥有生产活塞行业先进的浇注机，活塞加工设备及检测设备，为产品的质量提供了可靠的保证。

自公司创建以来一直致力于生产与开发轿车活塞，为汽车维修市场提供了优质的发动机活塞；经过 10 余年发展在生产规模产品研发中已积累了雄厚的实力和技术经验。

公司本着“与时俱进”的精神，竭诚欢迎国内外新老客户的惠顾，通力合作，携手共创辉煌。

Ruian Boda Piston Co.,Ltd., a professional manufacturer of pistons for automobiles, is located in the international Automobile & Motorcycle Spare City-Ruian City, Zhejiang Province, where enjoys a good environment for producing,

living and transporting by sea, land and air.

The Company occupies 2100 square meters of land area, and has fixed assets worth 8 million RMB, an annual output of 650000 pistons for all models of automobiles. It carries out standardization, quantitative determination, systematization and normalization in management in the company.

It has advanced pouring machines, processing and testing equipments for pistons in the piston industry, which is a reliable assurance for quality products .

Since its establishment, the company has been dedicated itself to the manufacture and development of pistons for passenger car series , supplying quality generator pistons for the automobile maintenance market . Over ten years' development, the company has accumulated tremendous strength and abundant technological experiences in the producing, researching and developing products.

The Company abides by the spirit “Advance with Time” , wholeheartedly welcoming the customers from at home and abroad to cooperate with us to achieve remarkable contribution

RUIAN BODA PISTON CO.,LTD.

我们优势来源于持续不断的技术创新、国内外一流的生产设备使我们的生产、检测、管理朝着更为完善的境界迈进。

We have great advantage in constant innovation of technology and domestic and foreign first-class production equipment, which enable us to go forward in the direction of production , inspection and management.

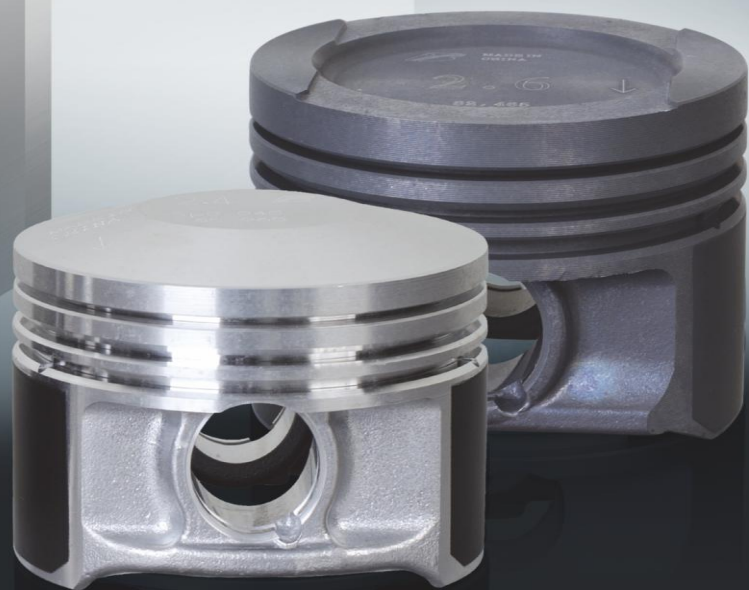

▪ <http://www.bdpiston.com>
E-mail: info@bdpiston.com



About product

高品质是赢得市场的保证，
而高品质需要有效的质量体系支撑，并确保质量管理体系有效运行，使产品质量不断的提高。

High quality is the guarantee to win the market while
As well known,good quality shall be supported by excellent
quality control system,
Accompanying with these systems executing,our products
quality has been improved little by little.



生产车间
Production Workshop



生产设备
Production Equipment



生产设备
Production Equipment



生产设备
Production Equipment

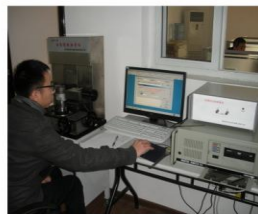

活塞测量
Piston Measurement

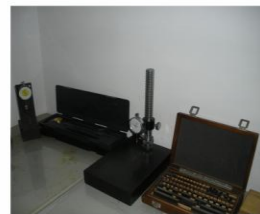

活塞检具
Piston gauge



活塞检具
Piston gauge



活塞浇注机
Casting Machine



活塞浇注机
Casting Machine

按目录顺序

According to the Catalog order

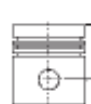
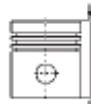
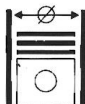

ACURA

BYP72010	86	51.50	29.60	16
BYP72411	87	51.90	29..50	16

ALFA ROMEO

BY82ALF	82	50.47	28.47	17
BY82BALF	82	56.70	32.90	17
BY83ALF	83	56.00	32.00	17
BY84ALF	84	61.00	35.00	17

ARO

BY73RN	73	62.70	37.50	18
BY76RN	76	62.60	37.60	18

AUDI

BYP2014	76.5	47.25	28.70	19
BYP714 STN1.8	81	62.50	32.20	19
BY1.6NJD	81	66.80	35.60	19
BY5VJD	81	57.00	32.70	19
BY1.8B5	81	52.55	32.55	19
BYP20018 AD200/1.8T	81	53.70	32.70	19
BYP712 B5/1.8T	81	53.70	32.70	20
BY2.2AD	81	62.30	32.20	20
BY2.2AD	81	62.30	32.20	20
BY1.8TA6	81	53.70	32.70	20
BY2.4AD	81	55.00	28.80	20
BY2.4C6	81	53.90	30.30	20
BY2.3AD	82.5	54.30	32.20	21
BYP20019 AD2.0	82.5	51.79	30.90	21
BY2.0NAD	82.5	51.79	30.90	21
BY100 2.0AD	82.5	63.79	30.90	21
BY2.0C6	82.5	50.50	29.60	21
BY2.6AAD	82.5	54.20	33.50	21
BY2.6BAD	82.5	54.20	33.50	22
BYP715 AD2.8	82.5	60.50	30.80	22
BY3.0AD	84.5	51.50	30.40	22

BMW

BY520BM	80	62.40	42.40	23
BY318BM	84	48.50	27.50	23
BY525BM	84	63.20	38.20	23
BY530BM	84	63.05	39.15	23
BY730BM	89	72.10	42.80	23
BY740BM	89	58.95	32.95	23

CHEVROLET

BYP1203	68.5	52.30	25.25	24
BY1.25GM	70.5	47.70	25.45	24
BY1.5GM	74.7	45.90	25.90	24

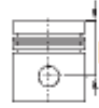
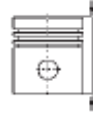
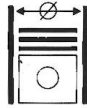

BYP412	77.6	52.50	32.05	24
BYP649	79	48.40	28.00	24
BY1.8GM	80.5	44.90	24.20	24
BYP9893 BY86OP	86	55.40	30.40	25
BYP7911	86	48.90	26.75	25
BYP457	89	57.90	37.10	25
BYP482	89	50.60	29.75	25
BYP962	89	59.90	37.80	25
BYP478	90	51.60	29.70	25
BYP567	101.6	81.05	39.20	26
BY101.6XFL	101.6	58.00	34.00	26
CHRYSLER				
BYP3055	86	53.20	31.20	27
BYP2023	86.5	72.10	35.50	27
BYP2044	86.5	67.20	35.00	27
BYP841	87.5	56.10	34.00	27
BYP219	87.5	71.25	40.45	27
BYP840	87.5	56.00	34.50	27
BYP852	87.5	55.20	30.65	28
BYP5242	88	51.47	27.50	28
BYP249	91.1	67.80	31.60	28
BYP225	93	53.70	31.75	28
BYP3209	96	57.00	34.97	28
BYP3210	96	54.30	32.55	28
BYP847	96	63.10	38.30	29
BYP3241	98.4	70.30	40.42	29
BYP1813	99.5	54.90	31.00	29
CITROEN				
BY1.4FK	75	64.00	40.50	30
BY77ZN	77	66.50	40.30	30
BY83PZ	83	56.30	33.30	30
BY88PZ	88	71.50	37.85	30
COMMER				
BY3.8PJS	98.48	121.10	70.30	31
BY5.8PJS	98.48	120.70	70.10	31
DACIA				
BY70RN	70	68.00	40.00	32
BY73RN	73	62.50	37.50	32
BYP1200	79.5	55.00	31.70	32
DAEWOO				
BYP1203	68.5	52.30	25.25	33
BY68.5DY	68.5	55.00	25.00.	33
BY1.5DY	76.5	48.00	28.00.	33
BY76.5DY	76.5	51.35	28.28.	33
BY1.6DY	79	49.80	27.80.	33
DAF				
BY70RN	70	68.00	40.00	34
BY73RN	73	62.50	37.50	34

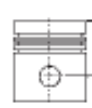
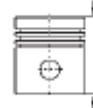
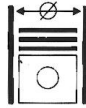

BY3.8PJS	98.48	121.10	70.30	34
DODGE				
BYP840	87.5	56.00	34.50	35
BYP841	87.5	56.10	34.00	35
BYP249	91.1	67.80	31.60	35
BYP225	93	53.70	31.75	35
BYP3210	96	54.30	32.55	35
BYP3209	96	57.00	34.97	35
EAGLE CHRYSLER				
BYP225	93	53.70	31.75	36
EICHER				
BY3.8PJS	98.48	121.10	70.30	37
FIAT				
BY133F08	65	63.00	32.50	38
BY131F13	76	78.45	38.45	38
BY141F652	77	79.20	39.70	38
BY128F11	80	77.30	34.70	38
BYP1201	80.5	45.10	24.10	38
BY1.4FIT	80.5	65.40	33.30	38
BY82BALF	82	56.70	32.90	39
BY132F18	84	79.85	38.45	39
BY132F2	84	77.95	38.45	39
BY84PZ	84	69.10	37.00	39
BY202F16	86.4	65.30	33.30	39
BY88PZ	88	71.50	37.85	39
FORD				
BYP802	74	53.90	29.40	40
BY1.3FD	74	53.90	29.40	40
BYP769	82	62.20	32.60	40
BYP6362 FD1.6	82	48.84	24.84	40
BYP6361	82	48.84	24.84	40
BYP822	84.8	53.40	29.40	40
BYP804	84.8	56.60	32.60	41
BYP828	84.8	56.90	33.10	41
BYP787	90.2	56.00	30.50	41
BYP819	90.2	52.00	31.00	41
BYP819-10N	90.2	52.00	31.00	41
BYP819-10	90.2	53.45	31.00	41
BYP5028	90.2	51.70	30.75	42
BY92.5FD	92.5	54.50	31.50	42
BYP763	93.5	77.50	38.60	42
BYP716	93.5	84.65	38.00	42
BY2.5FD	93.67	94.00	59.50	42
BYP777	96	72.20	40.08	42
BYP816	96	62.45	30.28	43
BYP805	96.8	68.60	40.80	43
BYP807	96.8	61.80	36.30	43
BYP814	96.8	59.33	32.30	43

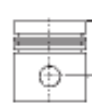
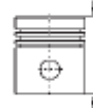
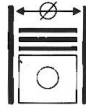

BYP3155	100.4	64.60	36.70	43
BYP735	101.6	85.60	40.71	43
BYP6620	102	55.60	33.50	44
FSO				
BY132F18	84	79.85	38.45	45
GAZ				
BY3.8PJS	98.48	121.10	70.30	46
GENERAL MOTORS				
BYP1203	68.5	52.30	25.25	47
BYP1027	79	51.70	32.20	47
BYP1914	79	51.70	32.20	47
BYP1201	80.5	45.10	24.10	47
BYP1202	80.5	44.70	24.10	47
BYP20103	84	58.95	29.39	47
BYP406	84	80.00	37.00	48
BYP821	86	54.00	29.90	48
BYP443	87	80.0	37.00	48
BYP962	89	59.90	37.80	48
BYP426	89	54.90	34.24	48
BYP457	89	57.90	37.10	48
BYP482	89	50.60	29.75	49
BYP485	89	51.00	30.55	49
BYP1258	93	50.20	28.15	49
BYP1258	93	50.20	28.15	49
BYP1258	93	50.20	28.15	49
BYP1258	93	50.20	28.15	49
BYP428	103	92.30	53.80	50
BYP1204	108	66.20	34.45	50
HENSCHEL				
BY3.8PJS	98.48	121.10	70.30	51
BY5.8PJS	98.48	120.70	70.10	51
HONDA				
BYP72010	86	51.50	29.60	52
HYUNDAI				
BY1.6ELT	77.4	58.95	31.00	53
BY1.8ELT	82	57.50	31.00	53
BYP2023	86.5	72.10	35.50	53
BYP249	91.1	67.80	31.60	53
IMT				
BY3.8PJS	98.48	120.70	70.10	54
INFINITI				
BYP2611	87	67.00	32.00	55
BYP11108	98	52.00	31.65	55
ISUZU				
BYP406	84	80.0	37.00	56
BYP443	87	80.00	37.00	56
BYP2021	92.6	79.00	36.50	56
BYP1258	93	50.20	28.15	56

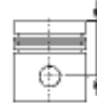
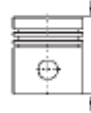
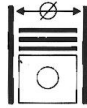

JEEP

BYP5242	88	51.47	27.50	57
BYP823	98.4	85.50	40.30	57
BYP3241	98.4	70.30	40.42	57

JOHN DEERE

BY5.8PJS	98.48	120.70	70.10	58
----------	-------	--------	-------	----

KIA

BY67KIA	67	48.66	24.66	59
BY1.1KIA	71	62.80	32.55	59
BY1.3KIA	71	58.00	28.70	59

LADA

BY1.2LD	76	77.00	38.00	60
BY2101LD	76	77.00	38.00	60
BY2108LD	76	65.90	37.90	60
BY11194LD	76.5	45.15	25.65	60
BY1.3LD	79	77.00	38.00	60
BY21011LD	79	77.00	38.00	60
BY2105LD	79	77.00	38.00	61
BYP1200	79.5	55.00	31.70	61
BY21083LD	82	65.90	37.90	61
BY21116LD	82	45.15	25.65	61
BY21213LD	82	65.90	37.90	61
BY21126LD	82.5	45.15	25.65	61

LANCIA

BY132F18	84	79.85	38.45	62
BY132F2	84	77.95	38.45	62

LAND ROVER

BYRV80	80	45.65	22.70	63
--------	----	-------	-------	----

LEYLAND

BY5.8PJS	98.48	120.70	70.10	64
----------	-------	--------	-------	----

LOTUS

BYRV80	80	45.65	22.70	65
--------	----	-------	-------	----

MASSEY-FERGUSON

BY3.8PJS	98.48	121.10	70.30	66
BY5.8PJS	98.48	120.70	70.10	66

MAZDA

BYP802	74	53.90	29.40	67
BYAC8A	83	53.90	29.90	67
BYP2606	92	74.60	36.50	67
BYP816	96	62.45	30.28	67
BYP3155	100.4	64.60	36.70	67

MG

BYRV80	80	45.65	22.70	68
--------	----	-------	-------	----

MITSUBISHI

BY73MI	73	72.00	39.00	69
BYP2044	86.5	67.20	35.00	69
BYP2023	86.5	72.10	35.50	69
BYP249	91.1	67.80	31.60	69

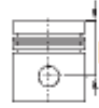
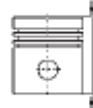
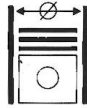

BYP225	93	53.70	31.75	69
NISSAN				
BYP2599	76	62.35	32.50	70
BYP2610	76	53.60	29.35	70
BY77NS	77	83.00	44.40	70
BY77ZN	77	66.50	40.30	70
BY2.0VG	78	65.50	30.50	70
BYP1200	79.5	55.00	31.70	70
BYP1100	80	53.75	29.25	71
BYP615	80.5	65.50	32.50	71
BYP2620	85	66.70	31.50	71
BYP2611	87	67.00	32.00	71
BYP2612	89	68.00	33.60	71
BYP2810	89	58.15	37.15	71
BYP2811	89	55.00	32.00	72
BYP2619	89	68.20	34.00	72
BYP2619U	89	60.90	34.00	72
BYP13401	95.5	55.00	31.45	72
BYP11108	98	58.90	31.00	72
OKTOBAR 14				
BY5.8PJS	98.48	120.70	70.10	73
OPEL				
BY72.5OP	72.5	45.00	24.00	74
BY73.4POP	73.4	44.00	23.00	74
BY73.4ROP	73.4	46.80	25.80	74
BYP412	77.6	52.50	32.05	74
BYP649	79	48.40	28.00	74
BY79OP	79	48.70	28.00	74
BY79AOP	79	50.20	27.20	75
BY79BOP	79	48.00	28.00	75
BY79POP	79	48.73	26.73	75
BY79ROP	79	48.70	26.70	75
BY79TOP	79	44.50	27.45	75
BYP1201	80.5	45.10	24.10	75
BYP1202	80.5	44.70	24.10	76
BY81.6OP	81.6	50.40	30.40	76
BY84.8OP	84.8	53.65	33.65	76
BY84.8AOP	84.8	53.65	33.65	76
BYP7911	86	48.90	26.75	76
BYP9893 BY86OP	86	55.40	30.40	76
BY86BOP	86	55.40	30.40	77
BY2.6OP	88.8	69.00	39.20	77
BY2.4OP	95	61.00	31.50	77
PERKINS				
BY3.8PJS	98.48	121.10	70.30	78
BY5.8PJS	98.48	120.70	70.10	78
BY5.8PJS	98.48	120.70	70.10	78
PEUGEOT				

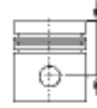
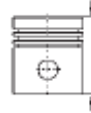
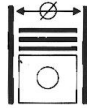

BYP1413	75	48.93	27.75	79
BY1.4FK	75	64.00	40.50	79
BY77ZN	77	66.50	40.30	79
BYP1414	78.5	50.15	32.35	79
BY83PZ	83	56.30	33.30	79
BY84PZ	84	69.10	37.00	79
BY88PZ	88	71.50	37.85	80
RENAULT				
BY58RN	58	64.00	30.00	81
BY70RN	70	68.00	40.00	81
BY73RN	73	62.70	37.50	81
BY75.8RN	75.8	52.60	31.70	81
BY76RN	76	62.60	37.60	81
BYP1200	79.5	55.00	31.70	81
BYRN79.5LH01	79.5	64.50	37.20	82
BYRN79.5LH02	79.5	52.85	28.33	82
BY81RN	81	70.10	44.10	82
ROVER				
BYRV75	75	46.79	23.84	83
BYRV80	80	45.65	22.70	83
RVI				
BY3.8PJS	98.48	120.70	70.10	84
SAAB				
BYP1202	80.5	44.70	24.10	85
SEAT				
BY133F08	65	63.00	32.50	86
BY1.3GIF	75	69.87	42.87	86
BY1.4GIF	75	52.02	34.52	86
BY1.6GIF	76.5	54.00	32.00	86
BYJDCY	79.5	60.70	39.80	86
BYP714 STN1.8	81	62.50	32.20	86
BYP712 B5/1.8T	81	53.70	32.70	87
BYP20018 /AD200/1.8T	81	53.70	32.70	87
BY1.6NJD	81	66.80	35.60	87
BY2.2AD	81	62.30	32.20	87
BY1.8T A6	81	53.70	32.70	87
BYP20019 AD2.0	82.5	51.79	30.90	87
BY132F18	84	79.85	38.45	88
BY132F2	84	77.95	38.45	88
SKODA				
BY75.5SKD	75.5	57.35	34.35	89
BYJDCY	79.5	60.70	39.80	89
BY5VJD	81	57.00	32.70	89
BYP712 B5/1.8T	81	53.70	32.70	89
BYP20018 /AD2001.8T	81	53.70	32.70	89
BY1.8TA6	81	53.70	32.70	89
SUZUKI				
BY465LM	65	52.50	25.50	90

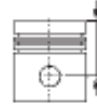
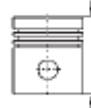
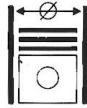

BY72ZN	72	55.00	28.00	90
BYP20103	84	58.95	29.39	90
BYP20103	84	58.95	29.39	90
TOYOTA				
BYP2665	75	49.80	30.70	91
BYP1914	79	51.70	32.20	91
BYP1027	79	51.70	32.20	91
BY87.1CMR	87.1	63.00	32.50	91
BYP2666	87.5	63.00	33.65	91
BYP1026	88.5	55.70	35.70	91
BY4YJB	91	65.00	35.00	92
BYP9023	92	92.30	39.00	92
VAUXHALL				
BY72.5OP	72.5	45.00	24.00	93
BYP412	77.6	52.50	32.05	93
BY79OP	79	48.70	28.00	93
BY79AOP	79	50.20	27.20	93
BY79BOP	79	48.00	28.00	93
BYP1202	80.5	44.70	24.10	93
BY81.6OP	81.6	50.40	30.40	94
BY84.8OP	84.8	53.65	33.65	94
BYP9893 BY86OP	86	55.40	30.40	94
BY86BOP	86	55.40	30.40	94
VOLKSWAGEN				
BYSP590	67.11	41.77	23.27	95
BY1.3GIF	75	69.87	42.87	95
BY1.4GIF	75	52.02	34.52	95
BY1.6GIF	76.5	54.00	32.00	95
BYP2014	76.5	47.25	28.70	95
BYJDCY	79.5	60.70	39.80	95
BYP714 STN1.8	81	62.50	32.20	96
BYP714 STN1.8	81	62.50	32.20	96
BYP20105	81	64.35	38.25	96
BYP713	81	57.30	32.20	96
BY1.6NJD	81	66.80	35.60	96
BY1.6BR	81	57.00	32.70	96
BY1.8LSJ	81	53.50	32.50	97
BY1.6L99	81	51.60	30.60	97
BYP712 B5/1.8T	81	53.70	32.70	97
BY2VJD	81	53.00	32.00	97
BY2000STN	81	53.50	32.50	97
BY5VJD	81	57.00	32.70	97
BY1.8B5	81	52.55	32.55	98
BY1.8TA6	81	53.70	32.70	98
BYP20018 AD200/1.8T	81	53.70	32.70	98
BY2.2AD	81	62.30	32.20	98
BY2.2AD	81	62.30	32.20	98
BY3000STN	81	53.50	32.50	98

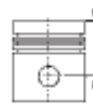
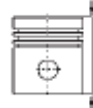
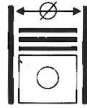

BYSTN3000G	81	50.00	29.00	99
BYSTN3000G6	81.02	51.00	30.00	99
BYSTN2000G6	81.02	59.70	38.70	99
BY2.0NAD	82.5	51.79	30.90	99
BYP20017 B52.0	82.5	50.30	29.30	99
BYP20019 AD2.0	82.5	51.79	30.90	99
BY3.0AD	84.5	51.50	30.40	100
BY85.5VW	85.5	82.50	39.40	100
BY87VW	87	82.50	39.40	100
BY90.5VW	90.5	72.10	39.60	100
BY92VW	92	74.40	39.60	100
BY94BVW	94	74.40	39.60	100
VOLVO				
BY70RN	70	68.00	40.00	101
BY73RN	73	62.70	37.50	101
BY76RN	76	62.60	37.60	101
BY81RN	81	70.10	44.10	101
ZASTAVA				
BY1.2LD	76	77.00	38.00	102
BY128F11	80	77.30	34.70	102
BY132F18	84	79.85	38.45	102
AUTO				
BY465Q1	65.5	55.00	24.55	103
BY465Q5	66	54.10	23.60	103
BYB12D	69.7	46.00	25.95	103
BYDK13	73	47.90	26.00	103
BY473	73	44.80	26.20	103
BY474Q	74	56.10	29.10	103
BYB15D	74.7	43.50	25.50	104
红旗 小解放				
BY2.0VG	78	65.50	30.50	105
BY488HC	87.5	71.25	40.45	105
BY488DC	87.5	71.25	40.45	105
BY488HD	87.5	56.00	34.50	105
BY488DD	87.5	56.00	34.50	105
航模				
DLE61	47	37.00	18.50	106
DLE120H	47	39.00	19.00	106
DLE106	52	53.00	21.00	106
DLE3000	110	65.00	32.00	106
COMPRESSOR				
BYMC18L	46	80.00	52.00	107
BYMC32L	50	80.00	52.00	107
BYCT125	55	38.65	26.50	107
BYBF63.5A	63.5	59.50	26.85	107
BYBF63.5B	63.5	59.50	26.85	107
BYBF66.7	66.7	46.05	23.85	107
BYCI1657	69.85	49.78	26.30	108

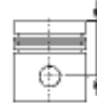
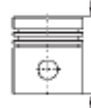
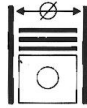









BYBF1657	69.85	49.78	26.30	108
BYCI1749	69.85	49.78	26.30	108
BYBF1749	69.85	49.78	26.30	108
BYBF75	75	57.50	27.80	108
BYBF75A	75	60.00	31.00	108
BYBF 75B	75	60.00	31.00	109
BYBF75C	75	52.78	32.15	109
BYRL75	75	60.00	31.00	109
BYPI 75	75	60.00	31.00	109
BYPI 77	77	59.00	30.00	109
BYBF80A	80	64.00	31.00	109
BYBF80B	80	49.90	26.05	110
BYBF82A	82	51.80	28.50	110
BYBF82B	82	48.90	26.23	110
BY PI85	85	59.00	33.32	110
BYBF85.5	85.72	61.80	36.45	110
BYBF86	86	57.00	26.60	110
BYPI88	88	62.40	31.50	111
BYPI90B	90	57.50	35.00	111
BYPI90	90	67.00	37.00	111
CA112	90	59.00	35.00	111
BYBF92	92	68.00	31.00	111
BYBF92.1	92.08	73.30	33.55	111
BYPI94	94	52.30	27.00	112
BY9500	95	70.00	36.00	112
BYBF100A	100	52.20	30.40	112
BYBF100B	100	52.20	30.40	112
BYGT100	100	74.00	40.15	112
BYCY100	100	74.00	40.15	112
BYWP18L	100	79.00	50.00	113
BYWP32L	110	90.00	50.00	113
BYMC40L	136	110.00	65.00	113
BYMC62L	136	100.00	60.00	113
BYWP110	136	306.00	191.00	113

按产品直径排序

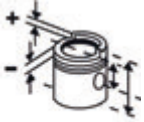
Sort by Diameter



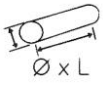

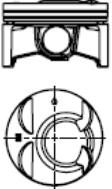
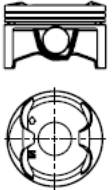



114-122







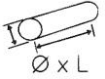

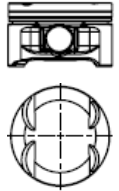
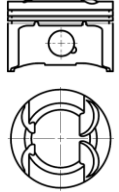
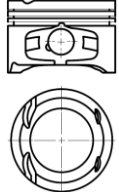
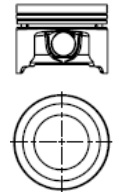

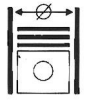
114-122

							
编号 Number	缸径(Φ) Cylinder Diameter(Φ)	外形数据 Overall data	适用车型 Applicable models of automobiles	发动机 Generator	缸数 Number of cylinders	活塞销 Piston Pin	活塞环 Piston ring
BYP72010	86	51.50 29.60 	RSX	K20A3 2.0L	4	22X52	1.2 1.2 2
BYP72411	87	51.90 29..50 	TSX	K24A2 2.4L	4	22X52	1.2 1.2 2

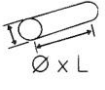
ALFA ROMEO (阿尔法罗密欧)

















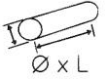

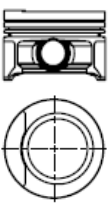
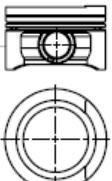
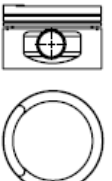
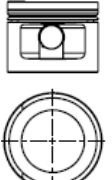
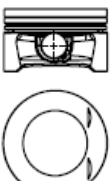
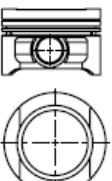
							
编号 Number	缸径(Φ) Cylinder Diameter(Φ)	外形数据 Overall data	适用车型 Applicable models of automobiles	发动机 Generator	缸数 Number of cylinders	活塞销 Piston Pin	活塞环 Piston ring
BY82ALF	82	50.47 28.47 	147.156	AR 32103 Euro AR 32104 Euro 1.6L	4	20X52	1.2 1.2 2
BY82BALF	82	56.70 32.90+1.8 	145.146.155.156	AR 676.01 M654 DA 15.T	4	20X52	1.2 1.2 2
BY83ALF	83	56.00 32.00-3.1 	145.146.155.156.166	M 647 CA 19.T 2.0L	4	20X52	1.2 1.5 3
BY84ALF	84	61.00 35.00-6 	145. 146	AR332.01 M690 .AA.16.T	4	21X61.5	1.5 1.5 3.5







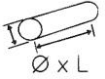

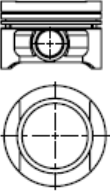
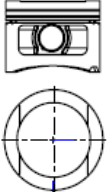
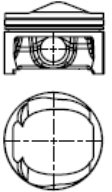
							
编号 Number	缸径(Φ) Cylinder Diameter(Φ)	外形数据 Overall data	适用车型 Applicable models of automobiles	发动机 Generator	缸数 Number of cylinders	活塞销 Piston Pin	活塞环 Piston ring
BY73RN	73	62.70 37.50+0.20  	100.101.103.104	1.A.P.810-R-99	4	20×62	1.75 2 4
BY76RN	76	62.60 37.60  	10-0 .10-1 .10-3 .10-4	1.4	4	20×64	1.75 2 4

							
编号 Number	缸径(Φ) Cylinder Diameter(Φ)	外形数据 Overall data	适用车型 Applicable models of automobiles	发动机 Generator	缸数 Number of cylinders	活塞销 Piston Pin	活塞环 Piston ring
BYP2014	76.5	47.25 28.70-6.8  	A3	EA111.FLEX.1.6L	4	17X52	1.2 1.5 2.5
BYP714 STN1.8	81	62.50 32.20+1.3-8.1  	80.90.100.4000.5000.FOX	DR.JN.MG.PM. RU.SF	4/5	20x57	1.5 1.75 3
BY1.6NJD	81	66.80 35.60+2.2-2.3  	80(B2.B4)	ABM.JU	4	20x57	1.5 1.75 3
BY5VJD	81	57.00 32.70-0.6  	A3.A4.A6. CABRIOLET	AHP 5V	4	20x59	1.5 1.75 2
BY1.8B5	81	52.55 32.55  	A6	ANQ	4	20X52	1.5 1.75 2
BYP20018 AD200/1.8T	81	53.70 32.70-1.5  	200.A3(8L1) .A4(B4) .A6(C5)	AEB	4	20x59	1.5 1.75 2

							
编号 Number	缸径(Φ) Cylinder Diameter(Φ)	外形数据 Overall data	适用车型 Applicable models of automobiles	发动机 Generator	缸数 Number of cylinders	活塞销 Piston Pin	活塞环 Piston ring
BYP712 B5/1.8T	81	53.70 32.70-1.9  	A3(8L1).A4(B6). TT(8N3)	ANQ	4	19X50	1.5 1.75 2
BY2.2AD	81	62.30 32.20+1.3-4.4  	80(B2 B3). 100(C3).COUPE	DS.DZ.JV.NE.PH	4	20x57	1.5 1.75 3
BY2.2AD	81	62.30 32.20+1.1-4.6  	90(B2).100(C3). 200(44Q).COUPE	KU.KV.DS.DZ . JV.NE.PH	5	20x57	1.5 1.75 3
BY1.8TA6	81	53.70 32.70-1.9  	A3(8L1).A4.(B6). TT(8N3)	AJQ	4	19x50	1.5 1.75 2
BY2.4AD	81	55.00 28.80+5.2  	A4(B5 B6).A6(C5)	AGA .AJG .ALF	6	21x56	1.5 1.5 2
BY2.4C6	81	53.90 30.30-2.9  	A4 (4F2) .A6(4F5)	BDW	6	20X44	1.2 1.5 2

							
编号 Number	缸径(Φ) Cylinder Diameter(Φ)	外形数据 Overall data	适用车型 Applicable models of automobiles	发动机 Generator	缸数 Number of cylinders	活塞销 Piston Pin	活塞环 Piston ring
BY2.3AD	82.5	54.30 32.20+1.1-4.4 	80(B3.B4).90(B3) 100(C3.C4).200(44Q). A6(C4.B4)	AAR. NF. NG	5	20X57	1.5 1.75 3
BYP20019 AD2.0	82.5	51.79 30.90+0.89-5 	80(B3.B4).100(C4). A6(C4.B4).COUPE	AAD .ABK	4	21x56	1.2 1.5 2
BY2.0NAD	82.5	51.79 30.90+0.89-7.2 	80(B4).100(C4).A6(C4)	AAE .ABT .ADW	4	21x56	1.2 1.5 2
BY100 2.0AD	82.5	63.79 30.90+089-8.2 	100. 80(B4) .4A-R-050000 8C-R-125000	AAE .ABT	4	21X59	1.2 1.5 2
BY2.0C6	82.5	50.50 29.6-6.05 	A6(C6)	2.0L	4	20X59	1.2 1.5 2
BY2.6AAD	82.5	54.20 33.50+0.7-3 	80(B4).100(C4). A4(B5).A6(C4.B4)	ABC .ACZ	6	21x56	1.5 1.75 3

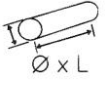
							
编号 Number	缸径(Φ) Cylinder Diameter(Φ)	外形数据 Overall data	适用车型 Applicable models of automobiles	发动机 Generator	缸数 Number of cylinders	活塞销 Piston Pin	活塞环 Piston ring
BY2.6BAD	82.5	54.20 33.50+0.7-3 	80(B4).100(C4).A4(B5).A6(C4.B4)	ABC. ACZ	6	21x56	1.5 1.75 3
BYP715 AD2.8	82.5	60.50 30.80+0.7-4.25 	80(B4).100(C4).A4(B5).A6(C4).A8(4D2.4D8)	AAH.AEJ.AFC	6	21X56	1.2 1.5 2
BY3.0AD	84.5	51.50 30.40 	A8	CGEA. CGFA. CJTA	6	22X59	1.2 1.5 2

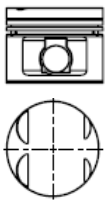
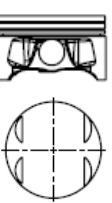
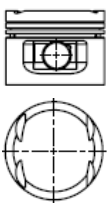
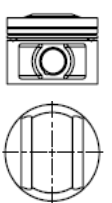
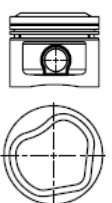
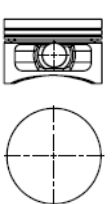
							
编号 Number	缸径(Φ) Cylinder Diameter(Φ)	外形数据 Overall data	适用车型 Applicable models of automobiles	发动机 Generator	缸数 Number of cylinders	活塞销 Piston Pin	活塞环 Piston ring
BY520BM	80	62.40 42.40-1.31-3.13 	320 i .520 i	M 50 .B20	6	22X54	1.5 1.75 3
BY318BM	84	48.50 27.50 	318 2.0i	B20A .B20LC	4	20X50	1.2 1.5 2
BY525BM	84	63.20 38.20-4.01 	325 i .525 i	M 50 .B 25 M	6	22X54	1.5 1.75 3
BY530BM	84	63.05 39.15+3.4 	530 i .730 i	M 60 .B 30	8	22X52	1.5 1.5 2
BY730BM	89	72.10 42.80+3.3 	530 i .730 i	M 30 .B 30 .M.E.7	6	22X62	1.5 2 3.5
BY740BM	89	58.95 32.95 	540 i .740 i .840 i	M 60 .B 40	8	22X58	1.5 1.5 2

							
编号 Number	缸径(Φ) Cylinder Diameter(Φ)	外形数据 Overall data	适用车型 Applicable models of automobiles	发动机 Generator	缸数 Number of cylinders	活塞销 Piston Pin	活塞环 Piston ring
BYP1203	68.5	52.30 25.25-1  	B10S1 .SOHC. MATIZ	3EA.YSE. F6B.1.0L	4	17X53	1.2 1.2 2.5
BY1.25GM	70.5	47.70 25.45  	SPARK	1.25L	4	18X48	1 1.2 2
BY1.5GM	74.7	45.90 25.90  	COBALT	1.5L	4	18X48	1 1.2 2
BYP412	77.6	52.50 32.05-3.4  	CORSA.GASOLINA	C14ES	4	18X55	1.5 1.5 3
BYP649	79	48.40 28.00+0.4-1.6  	CORSA.(PICK-UP).CORSA MPFI.GAS.C16NE	1.6 L	4	18X55	1.2 1.5 3
BY1.8GM	80.5	44.90 24.20  	LACETTI	1.8L	4	18X55	1.2 1.2 2





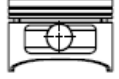



CHEVROLET (雪佛兰)



							
编号 Number	缸径(Φ) Cylinder Diameter(Φ)	外形数据 Overall data	适用车型 Applicable models of automobiles	发动机 Generator	缸数 Number of cylinders	活塞销 Piston Pin	活塞环 Piston ring
BYP9893 BY86OP	86	55.40 30.40-5  	SUNBIRD.SKYHAWK LEMANS.FIRENZA	122CID. 2.0L	4	21X61.5	1.5 1.5 3
BYP7911	86	48.90 26.75-0.61  	ECOTEC.ASTRA,CAVALIER, MALIBU, VECTRA 01-08	2.2 ITS	4	20X62	1.2 1.5 2.5
BYP457	89	57.90 37.10-6.6  	CELEBRITY.CORSICA.CUTLASSC RUISER GRAND AM.REGAL.SKYLARK.SUNBIRD	189CID. 3.1L	6	23X65	1.5 1.5 4
BYP482	89	50.60 29.75-5.1  	BERETTA.CAVALIER. CORSICA.TEMPEST	134CID. 2.2L	4	20.33X67	1.5 1.5 3
BYP962	89	59.90 37.80-6.6  	FALDA .GRAFITADA	MOT.3.1L- (189)	6	23X57	1.2 1.5 3
BYP478	90	51.60 29.70-0.9  	ACHIEVA.CAVALIER.GRAND AM. MALIBU.SKYLARK.SUFIRE	146CID. 2.4L	4	22X61.5	1.2 1.5 3



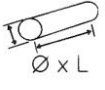

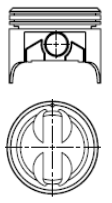
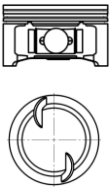



CHEVROLET (雪佛兰)



							
编号 Number	缸径(Φ) Cylinder Diameter(Φ)	外形数据 Overall data	适用车型 Applicable models of automobiles	发动机 Generator	缸数 Number of cylinders	活塞销 Piston Pin	活塞环 Piston ring
BYP567	101.6	81.05 39.20-1.9 	ACADIAN.APOILO.BELAIR DEVILLEBISCAYNE.BROUGHAM	350CID. 5.7L	8	23.55X76	2 2 4.8
BY101.6XFL	101.6	58.00 34.00-1.2 			8	23.95X65.5	1.2 1.5 2.5

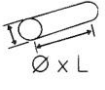

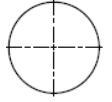
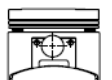
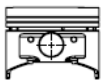
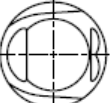
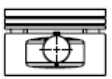
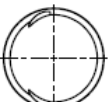
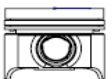
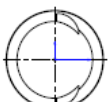
CHRYSLER (克莱斯勒)



							
编号 Number	缸径(Φ) Cylinder Diameter(Φ)	外形数据 Overall data	适用车型 Applicable models of automobiles	发动机 Generator	缸数 Number of cylinders	活塞销 Piston Pin	活塞环 Piston ring
BYP3055	86	53.20 31.20  	ONCORDE/INTREPI SEBRING/STRATUS.MAGNUM	167CID.EER. 2.7L	6	22X60	1.5 1.5 3
BYP2023	86.5	72.10 35.50+0.35  	SUMMIT.WAGON.COLT. VISTA. RAM50	G64B(W). 4G64(G/W).2.4L	4	21X72	1.5 1.5 4
BYP2044	86.5	67.20 35.00+0.35  	RAM50	4G64. 2.4L	4	22x62	1.2 1.5 3
BYP841	87.5	56.10 34.00-7.5  	DAYTONA.CARAVAN.VOYAGER SUNDANCE.LANCER.RAM.VAN	153J. 2.5L	4	22.88X63.5	1.5 1.5 4
BYP219	87.5	71.25 40.45-1.6  	600.ACCLAIM.ARIES.CARAVELLE. DAYONA.EXPO.HORIZON. LANCER.LASER	135CID. 2.2L	4	22.88X70	1.5 1.5 4
BYP840	87.5	56.00 34.50-3.5  	ENG.EXC.TURBO	153K. 2.5	4	22.88X61.5	1.5 1.5 4





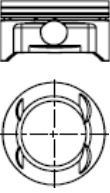
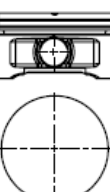







CHRYSLER (克莱斯勒)



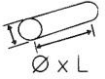



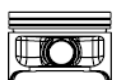
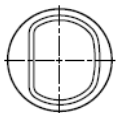



							
编号 Number	缸径(Φ) Cylinder Diameter(Φ)	外形数据 Overall data	适用车型 Applicable models of automobiles	发动机 Generator	缸数 Number of cylinders	活塞销 Piston Pin	活塞环 Piston ring
BYP852	87.5	55.20 30.65+6.1 	BREEZE.CIRRUS SEBRING.STRATUS	148CID 2.4L	4	22X72	1.2 1.5 3
BYP5242	88	51.47 27.50 	JOURNEY, COMPASS, PATRIOT, PT, CRUISER, AVANGER, CALIBER, 07-10	144CID 2.4LT	4	21X59	1.2 1.2 2
BYP249	91.1	67.80 31.60 	VOYAGER.STEALTH.CARAVAN. MINI-RAM.RAIDER.RAM50	6G72(3).6G72(5)6 G72(S)	6	22X64	1.5 1.5 4
BYP225	93	53.70 31.75-2.4 	CONCORDE.DYNASTY.LMPERIAL .LNTREPID.NEW.YORKER	201CID. 3.3L	6	22.885X67. 5	1.5 1.5 3
BYP3209	96	57.00 34.97-5.2 	IMPERIAL.NEWYORKER	230CID .3.8L	6	22.885X67. 5	1.5 1.5 3
BYP3210	96	54.30 32.55 	.GRANDCARAVAN. TOWN&COUNTRY.VOYAGER	230CID .3.8L	6	22.885X67. 5	1.5 1.5 3



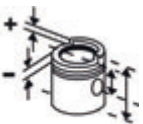



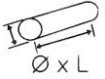

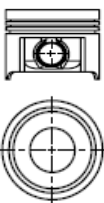
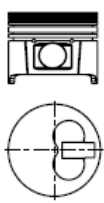
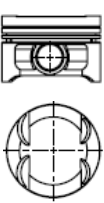
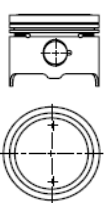



CHRYSLER (克莱斯勒)

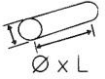

							
编号 Number	缸径(Φ) Cylinder Diameter(Φ)	外形数据 Overall data	适用车型 Applicable models of automobiles	发动机 Generator	缸数 Number of cylinders	活塞销 Piston Pin	活塞环 Piston ring
BYP847	96	63.10 38.30+0.8  	CONCORDE.LNTREPID.LHS NEW.YORKER.PROWLER	215CID. 3.5L	6	24X61	1.2 1.5 3
BYP3241	98.4	70.30 40.42-3.1  	CHEROKEE, RUBICON, SAHARA, WRANGLER 96-06	242CID. 4.0L	6	23.65X68.5	1.5 1.5 4
BYP1813	99.5	54.90 31.00+4  	300C.MAGNUM PICKUP.DURANGO	5.7 VIN D	8	24X70	1.5 1.5 3









CITROEN (雪铁龙)

							
编号 Number	缸径(Φ) Cylinder Diameter(Φ)	外形数据 Overall data	适用车型 Applicable models of automobiles	发动机 Generator	缸数 Number of cylinders	活塞销 Piston Pin	活塞环 Piston ring
BY1.4FK	75	64.00 40.50-1 	C15.AX.BX.ZX.BERLINGO	TU3A.TU3M	4	19.5×62	1.75 2 3
BY77ZN	77	66.50 40.30 	AX.SAXO.XSARA	TUD5	4	23X60	2 1.75 3
BY83PZ	83	56.30 33.30-1.00 	XSARA.ZX.PICASSO.XANTIA	LFY	4	22×62	1.5 1.5 3
BY88PZ	88	71.50 37.85-0.65 	C25 .E2.0	RN .XN .1 T	4	23×74	1.5 2 4





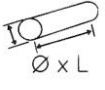

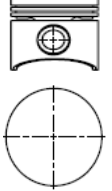
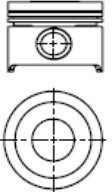
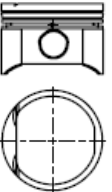

							
编号 Number	缸径(Φ) Cylinder Diameter(Φ)	外形数据 Overall data	适用车型 Applicable models of automobiles	发动机 Generator	缸数 Number of cylinders	活塞销 Piston Pin	活塞环 Piston ring
BY3.8PJS	98.48	121.10 70.30-20.8+3.2  	VBFS.VAFS	AD 4.236	4	34.925X84. 1	2.385 2.385 2.385 6.335
BY5.8PJS	98.48	120.70 70.10-25.7  	VAAS.VAAW.VBAS.VCA.LB6	6.354	6	34.925X84. 1	2.385 2.385 2.385 6.335 6.335

DACIA (达契亚)



							
编号 Number	缸径(Φ) Cylinder Diameter(Φ)	外形数据 Overall data	适用车型 Applicable models of automobiles	发动机 Generator	缸数 Number of cylinders	活塞销 Piston Pin	活塞环 Piston ring
BY70RN	70	68.00 40.00 	CARAVELLE.ESTAFETTE 800.MAJOR.R8.R10.R2132	688.01	4	18x62	1.75 2 3.5
BY73RN	73	62.50 37.50+0.2 	R12.R10	810.01-03	4	20x62	1.75 2 4
BYP1200	79.5	55.00 31.70-1.3 	LOGAN MCV	1.6L	4	20x62	1.5 1.5 2.5

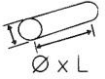

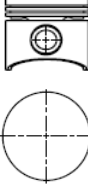
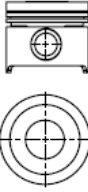
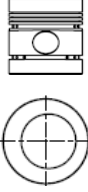





							
编号 Number	缸径(Φ) Cylinder Diameter(Φ)	外形数据 Overall data	适用车型 Applicable models of automobiles	发动机 Generator	缸数 Number of cylinders	活塞销 Piston Pin	活塞环 Piston ring
BYP1203	68.5	52.30 25.25-1  	MATIZ	3EA.YSE. F6B.1.0L	4	17X53	1.2 1.2 2.5
BY68.5DY	68.5	55.00 25.00-2.5  	MATIZ.TICO.	3EA.YSE. F6B.0.6L	3	16x53	1.2 1.5 2.8
BY1.5DY	76.5	48.00 28.00-3.2  	NEXIA SOHC	1.5.L	4	18x55	1.5 1.5 3
BY76.5DY	76.5	51.35 28.28-4.5  	NEXIA DOHC	1.5L	4	18x55	1.5 1.5 3
BY1.6DY	79	49.80 27.80-2.6  	NEXIA	1.6L	4	18x55	1.2 1.5 3







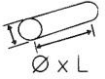

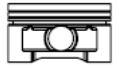
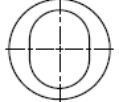

							
编号 Number	缸径(Φ) Cylinder Diameter(Φ)	外形数据 Overall data	适用车型 Applicable models of automobiles	发动机 Generator	缸数 Number of cylinders	活塞销 Piston Pin	活塞环 Piston ring
BY70RN	70	68.00 40.00 	55.66.SERIE	1.1	4	18x62	1.75 2 3.5
BY73RN	73	62.50 37.50+0.2 	66.SERIE	1.3	4	20x62	1.75 2 4
BY3.8PJS	98.48	121.10 70.30-20.8+3.2 	FA700.FA900	AD 4.236	4	34.925X84. 1	2.385 2.385 2.385 6.335

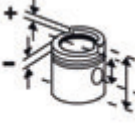
							
编号 Number	缸径(Φ) Cylinder Diameter(Φ)	外形数据 Overall data	适用车型 Applicable models of automobiles	发动机 Generator	缸数 Number of cylinders	活塞销 Piston Pin	活塞环 Piston ring
BYP840	87.5	56.00 34.50-3.5 	SHADOW,SPIRIT,PHANTON 89-94	153K. 2.5	4	22.88X61.5	1.5 1.5 4
BYP841	87.5	56.10 34.00-7.5 	SHADOW,SPIRIT,PHANTON 86-94 TURBO (C/SEGURO)	153J. 2.5L	4	22.88X63.5	1.5 1.5 4
BYP249	91.1	67.80 31.60 	VOYAGER,CARAVAN 87-00 (DELGADO)	6G72(3).6G72(5)6 G72(S)	6	22X64	1.5 1.5 4
BYP225	93	53.70 31.75-2.4 	CARAVAN.GRAND.VOYAGER. TOWN&COUNTRY.VOYAGER	201CID. 3.3L	6	22.885X67. 5	1.5 1.5 3
BYP3210	96	54.30 32.55 	.GRANDCARAVAN. TOWN&COUNTRY.VOYAGER	230CID .3.8L	6	22.885X67. 5	1.5 1.5 3
BYP3209	96	57.00 34.97-5.2 	.GRANDCARAVAN. TOWN&COUNTRY.VOYAGER	230CID .3.8L	6	22.885X67. 5	1.5 1.5 3

EAGLE CHRYSLER (老鷹)

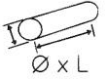















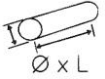

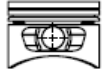
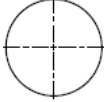
							
编号 Number	缸径(Φ) Cylinder Diameter(Φ)	外形数据 Overall data	适用车型 Applicable models of automobiles	发动机 Generator	缸数 Number of cylinders	活塞销 Piston Pin	活塞环 Piston ring
BYP225	93	53.70 31.75-2.4  	VISION	201CID. 3.3L	6	22.885X67. 5	1.5 1.5 3

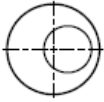
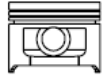
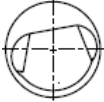
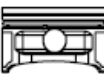

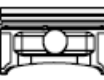
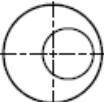
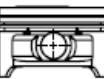
							
编号 Number	缸径(Φ) Cylinder Diameter(Φ)	外形数据 Overall data	适用车型 Applicable models of automobiles	发动机 Generator	缸数 Number of cylinders	活塞销 Piston Pin	活塞环 Piston ring
BY3.8PJS	98.48	121.10 70.30-20.8+3.2  	3453.MAMMUT II 74	A 4.236	4	34.925X84. 1	2.385 2.385 2.385 6.335



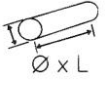











							
编号 Number	缸径(Φ) Cylinder Diameter(Φ)	外形数据 Overall data	适用车型 Applicable models of automobiles	发动机 Generator	缸数 Number of cylinders	活塞销 Piston Pin	活塞环 Piston ring
BY133F08	65	63.00 32.50  	133	DB-10.	4	20X54	1.75 2 3.94
BY131F13	76	78.45 38.45+0.5  	131	131A.000	4	22X60	1.5 2 3.95
BY141F652	77	79.20 39.70  	PANDA30 126	141 A 000 128 A1.000	2	20X61	1.5 2 3.947
BY128F11	80	77.30 34.70+0.6  	128 1.1 .RITMO60 1.1	128 AC5.000 128 A.000 128 BB.0A0 138 BB.0A.0	4	22X71	1.5 2 3.947
BYP1201	80.5	45.10 24.10-3.8+2.25  	STRADA.DOBLO.PALIO 1.8	GAS. 1.8L	4	18X57	1.2 1.2 2
BY1.4FIT	80.5	65.40 33.30-2.9  	SHAHIN	1400.CC	4	22X58	1.5 2 3

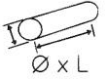

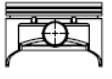

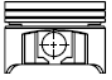

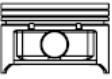
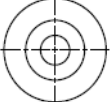
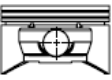
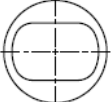
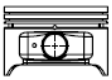
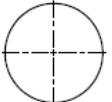
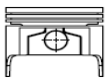

编号 Number	缸径(Φ) Cylinder Diameter(Φ)	外形数据 Overall data	适用车型 Applicable models of automobiles	发动机 Generator	缸数 Number of cylinders	活塞销 Piston Pin	活塞环 Piston ring
BY82BALF	82	56.70 32.90+1.8 	BRAVO.MAREA	182B 7.000 M 654 DA 15.T	4	20X52	1.2 1.2 2
BY132F18	84	79.85 38.45+1.6 	124.131.132.ARGENTA	132A132AB132C 132B.132BB	4	22X69	1.5 2 3.95
BY132F2	84	77.95 38.45 	131.132.ARGENTA	131B.132C. 132DB.132C	4	22X69	1.5 2 3.95
BY84PZ	84	69.10 37.00+1.1 	DUCATO 10.FURGONE	XM 7T	4	23x70	1.5 2 4
BY202F16	86.4	65.30 33.30-2.3 	TEMPRA.AK.SX	M202	4	22X63	1.5 1.75 3
BY88PZ	88	71.50 37.85+0.55 	DUCATO13 . DUCATO 18 . DUCATO 280	P170B	4	23x74	1.5 2 4







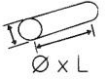

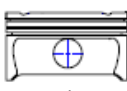
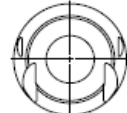

							
编号 Number	缸径(Φ) Cylinder Diameter(Φ)	外形数据 Overall data	适用车型 Applicable models of automobiles	发动机 Generator	缸数 Number of cylinders	活塞销 Piston Pin	活塞环 Piston ring
BYP802	74	53.90 29.40  	ESCORT. FIESTA. KA.ARG.ORION.GAS	B. C. EFI.OHV H.HCF.HCS	4	18.034X64	1.5 1.75 3
BY1.3FD	74	53.90 29.40-3.5  	ESCORT .ORION .FIESTA	CFI .OHV	4	18.034x64	1.5 1.75 3
BYP769	82	62.20 32.60-7.4  	ESCORT.EXP.LYNX.TRACER	116CID. 1.9L	4	20.63x70	1.5 1.5 3
BYP6362 FD1.6	82	48.84 24.84-3  	FIESTA.ESCORT. COURIER.KA.IKON	ZETEC..ZL 16	4	18.034x62	1.2 1.5 2
BYP6361	82	48.84 24.84-3  	FIESTA.ESCORT. COURIER.KA.IKON	ROCAM.ZL16	4	18.034x62	1.2 1.5 2
BYP822	84.8	53.40 29.40+0.8  	CONTOUR.MYSTIQUE.FOCUS ESCORT ZX2.COUGAR	121CID. 993(3) 2.0L	4	20X58	1.5 1.75 3





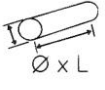





							
编号 Number	缸径(Φ) Cylinder Diameter(Φ)	外形数据 Overall data	适用车型 Applicable models of automobiles	发动机 Generator	缸数 Number of cylinders	活塞销 Piston Pin	活塞环 Piston ring
BYP804	84.8	56.60 32.60+1.3  	CONTOUR .COUGAR.FOCUS MYSTIQUE.ESCORT.ZX2	121CID.993(3) 2.0L	4	20.63X63.5	1.5 1.75 3
BYP828	84.8	56.90 33.10+4.5-5.7  	ESCORT .TRACER.FOCUS	122CID. 2.0L	4	20.63X63.5	1.5 1.5 3
BYP787	90.2	56.00 30.50-4  	GRAND MARQUIS, COBRA, LINCON TOWN CAR, ECONOLINE	281CID. 4.6L	8	22X67	1.5 1.5 3
BYP819	90.2	52.00 31.00-3.5  	CONTINENTAL.MARK VLLL	281CID. 4.6L	8	22X62	1.5 1.5 3
BYP819-10N	90.2	52.00 31.00-4.00  	E350.F250/350.E-SERIES ECONLOINE.EXCURSION	330CID. 5.4L 415CID. 6.8L	10	22X62	1.5 1.5 3
BYP819-10	90.2	53.45 31.00-1.3  	E350.F250/350.E-SERIES ECONLOINE.EXCURSION	330CID. 5.4L 415CID. 6.8L	10	22X62	1.5 1.5 3

							
编号 Number	缸径(Φ) Cylinder Diameter(Φ)	外形数据 Overall data	适用车型 Applicable models of automobiles	发动机 Generator	缸数 Number of cylinders	活塞销 Piston Pin	活塞环 Piston ring
BYP5028	90.2	51.70 30.75  	GT.MUSTANG.BLACKWOOD. NAVIGATOR	330CID. 5.4L	8	22X62	1.5 1.5 3
BY92.5FD	92.5	54.50 31.50+1  	EXPLORER.TAURUS	3.5L TI-VCT V6	6	23 X59	1.2 1.5 2.5
BYP763	93.5	77.50 38.60  	TOPAZ	2.3 ITS	4	23.17X77	2 2 4.8
BYP716	93.5	84.65 38.00-2.4  	110'' RECESSED HEAD	200	6	23.17X77	2 2 4.8
BY2.5FD	93.67	94.00 59.50-18  	TRANSIT. FLATBED	4AB.4BA. 4BB.4CA	4	29X77	2.5 2 4
BYP777	96	72.20 40.08  	BOBCAT.CAPRI.COUGAR FAIRMONT.GRANADA.LTD	140CID. 2.3L	4	23.17X77	1.5 1.5 4

							
编号 Number	缸径(Φ) Cylinder Diameter(Φ)	外形数据 Overall data	适用车型 Applicable models of automobiles	发动机 Generator	缸数 Number of cylinders	活塞销 Piston Pin	活塞环 Piston ring
BYP816	96	62.45 30.28-2.1  	RANGER .140,151	153CID .2.5L	4	23.17X66	1.5 1.5 3
BYP805	96.8	68.60 40.80-4  	CONTINENTAL.COUGAR.LTD GRANADA.MARQUIS.SABLE	232CID. 3.8L	6	23.17X77	1.5 1.5 4
BYP807	96.8	61.80 36.30-3  	WINDSTAR.F-100	232CID. 3.8L	6	23X70	1.5 1.5 3
BYP814	96.8	59.33 32.30-3.7  	E-150CLUB.WAGON. E-250 ECONOLINE.F-150.E-150	256CID. 4.2L	6	23X63	1.5 1.5 3
BYP3155	100.4	64.60 36.70  	COLOGNEVINE,K,N.EXPLORER,R ANGER,MUSTANG,LANDROVER	4016CC .4.0L	6	24X72	1.6 1.75 3.5
BYP735	101.6	85.60 40.71-2.5  	VERSAILLES.TOENCAR.MARK VITHUNDERBIRD.MUSTANG.	302CID. 5.0L	8	23.17X77	2 2 4.8

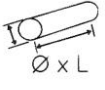

							
编号 Number	缸径(Φ) Cylinder Diameter(Φ)	外形数据 Overall data	适用车型 Applicable models of automobiles	发动机 Generator	缸数 Number of cylinders	活塞销 Piston Pin	活塞环 Piston ring
BYP6620	102	55.60 33.50-0.35  	SUPER DUTY SERIES F-150 SYT ROPTOR	6.2L9(379)SOHC 16 VAI VCT ROMEO VIN6	8	24X62	1.5 1.5 2.5

							
编号 Number	缸径(Φ) Cylinder Diameter(Φ)	外形数据 Overall data	适用车型 Applicable models of automobiles	发动机 Generator	缸数 Number of cylinders	活塞销 Piston Pin	活塞环 Piston ring
BY132F18	84	79.85 38.45+1.6  	132 P1800	132A.132B. 132AB.132BB	4	22X69	1.5 2 3.95

							
编号 Number	缸径(Φ) Cylinder Diameter(Φ)	外形数据 Overall data	适用车型 Applicable models of automobiles	发动机 Generator	缸数 Number of cylinders	活塞销 Piston Pin	活塞环 Piston ring
BY3.8PJS	98.48	121.10 70.30-20.8+3.2  	GAS53A	4.236	4	34.925X84. 1	2.385 2.385 2.385 6.335

GENERAL MOTORS(通用)



							
编号 Number	缸径(Φ) Cylinder Diameter(Φ)	外形数据 Overall data	适用车型 Applicable models of automobiles	发动机 Generator	缸数 Number of cylinders	活塞销 Piston Pin	活塞环 Piston ring
BYP1203	68.5	52.30 25.25-1  	MATIZ	3EA.YSE.F6B.1.0L	4	17X53	1.2 1.2 2.5
BYP1027	79	51.70 32.20-6.6  	PRIZM.VIBE	1ZZFE.1.8L	4	20X50	1.2 1.2 3
BYP1914	79	51.70 32.20-6.45  	PRIZM.VIBE	1ZZFE.1.8L	4	20X50	1.2 1.2 3
BYP1201	80.5	45.10 24.10-3.8+2.25  	CORSA.MONTANA.MERIVA	GAS. 1.8L	4	18X57	1.2 1.2 2
BYP1202	80.5	44.70 24.10  	MERIVA.STILO.FAMI-LIAI 1.8L	X18X E-1. 1.8L	4	18x57	1.2 1.2 2
BYP20103	84	58.95 29.39-4.85  	TRACKER	LE8. 2.5L	4/6	21X59	1.2 1.5 2.5





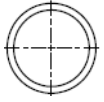
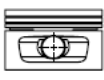



GENERAL MOTORS(通用)



							
编号 Number	缸径(Φ) Cylinder Diameter(Φ)	外形数据 Overall data	适用车型 Applicable models of automobiles	发动机 Generator	缸数 Number of cylinders	活塞销 Piston Pin	活塞环 Piston ring
BYP406	84	80.00 37.00-2  	PICKUP	G180Z(N). 1.8L	4	22×66	2 2 4
BYP821	86	54.00 29.90-5.4  	OMEGA.VECTRA.S-10	EFI.MPFI. 2.2L	4	21×66.5	1.5 1.5 3
BYP443	87	80.00 37.00  	PICKUP	G200Z(A). 2.0L	4	22×78	2 2 4
BYP962	89	59.90 37.80-6.6  	MALIBU 97-06	MOT.3.1L- (189)	6	23X57	1.2 1.5 3
BYP426	89	54.90 34.24-7.8  	CAVALIER.SUNFIRE. S10. SONOMA	134CID. 2.2L	4	20.33X61	1.5 1.5 3
BYP457	89	57.90 37.10-6.6  	CELEBRITY.CORSICA.CUTLASSC RUISER GRAND AM.REGAL.SKYLARK.SUNBIRD	189CID. 3.1L	6	23X65	1.5 1.5 4



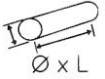

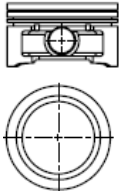
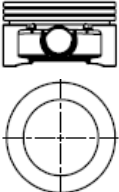
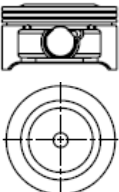
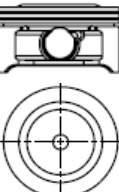
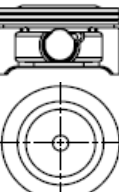
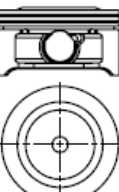



GENERAL MOTORS(通用)







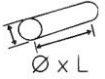

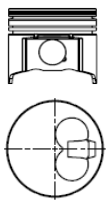
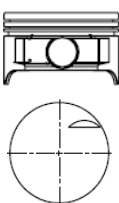



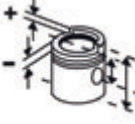



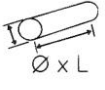







							
编号 Number	缸径(Φ) Cylinder Diameter(Φ)	外形数据 Overall data	适用车型 Applicable models of automobiles	发动机 Generator	缸数 Number of cylinders	活塞销 Piston Pin	活塞环 Piston ring
BYP482	89	50.60 29.75-5.1 	BERETTA.CAVALIER. CORSICA.TEMPEST	134CID. 2.2L	4	20.33X67	1.5 1.5 3
BYP485	89	51.00 30.55-1.6 	CAVALIER, CUTLASS, S10 98-03	134CID. 2.2L	4	20.33X61	1.5 1.5 3
BYP1258	93	50.20 28.15+2.35 	CANYON.COLORADO	169CID.LK5. 2.8L	4	23X65	1.2 1.5 2.5
BYP1258	93	50.20 28.15+2.35 	CANYON.COLORADO	211CID.LK5. 3.5L	5	23X65	1.2 1.5 2.5
BYP1258	93	50.20 28.15+2.35 	TRAILBLAZER.BRAVADA	254CID.LL8. 4.2L	6	23X65	1.2 1.5 2.5
BYP1258	93	50.20 28.15+2.35 	TRAILBLAZER.BRAVADA	281CID. 5.4L	8	23X65	1.2 1.5 2.5





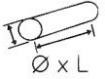

GENERAL MOTORS(通用)







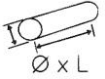

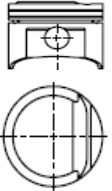
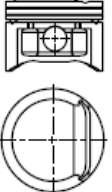
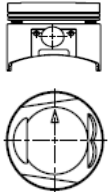
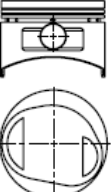







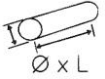

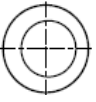

							
编号 Number	缸径(Φ) Cylinder Diameter(Φ)	外形数据 Overall data	适用车型 Applicable models of automobiles	发动机 Generator	缸数 Number of cylinders	活塞销 Piston Pin	活塞环 Piston ring
BYP428	103	92.30 53.80-1.7 	BLAZER.C1500.SUBURBAN. C3500.P30EXPRESS2500. 3500.G20.G2500.K1500	395CID. 6.5L	8	31X70	3 2 4
BYP1204	108	66.20 34.45 	AVALANCHE2500.C3500.EXPRES S3500SAVANA3500.SCHOOL BUS CHASSIS	496CID. 8.1L	8	26.42X66	2 2 4





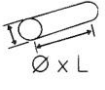

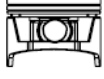
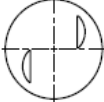





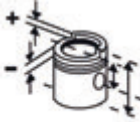

							
编号 Number	缸径(Φ) Cylinder Diameter(Φ)	外形数据 Overall data	适用车型 Applicable models of automobiles	发动机 Generator	缸数 Number of cylinders	活塞销 Piston Pin	活塞环 Piston ring
BY3.8PJS	98.48	121.10 70.30-20.8+3.2  	HC 7 TL.HC 9 TL	4.236	4	34.925X84. 1	2.385 2.385 2.385 6.335
BY5.8PJS	98.48	120.70 70.10-25.7  	HC 10 TL.HC 11 TL	6.354	6	34.925X84. 1	2.385 2.385 2.385 6.335 6.335

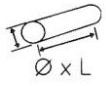

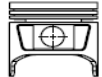



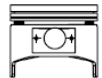

							
编号 Number	缸径(Φ) Cylinder Diameter(Φ)	外形数据 Overall data	适用车型 Applicable models of automobiles	发动机 Generator	缸数 Number of cylinders	活塞销 Piston Pin	活塞环 Piston ring
BYP72010	86	51.50 29.60  	CIVIC SI	K20A3 2.0L	4	22X52	1.2 1.2 2







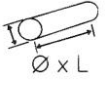

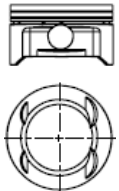
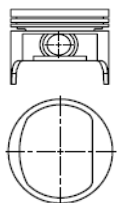
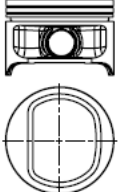

							
编号 Number	缸径(Φ) Cylinder Diameter(Φ)	外形数据 Overall data	适用车型 Applicable models of automobiles	发动机 Generator	缸数 Number of cylinders	活塞销 Piston Pin	活塞环 Piston ring
BY1.6ELT	77.4	58.95 31.00+1.8 	ELANTRA1.6 GLS	J2 (BETA)	4	20×59	1.2 1.2 2.5
BY1.8ELT	82	57.50 31.00+1.9 	ELANTRA 1.8 GLI	G4DR(BETA)	4	20×59	1.2 1.2 2.5
BYP2023	86.5	72.10 35.50+0.35 	SONATA	G64B. 2.4L	4	21×72	1.5 1.5 4
BYP249	91.1	67.80 31.60 	SONATA	6GAT. 3.0L	6	22×64	1.5 1.5 4





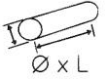



							
编号 Number	缸径(Φ) Cylinder Diameter(Φ)	外形数据 Overall data	适用车型 Applicable models of automobiles	发动机 Generator	缸数 Number of cylinders	活塞销 Piston Pin	活塞环 Piston ring
BY3.8PJS	98.48	120.70 70.10-25.7  	5101.5131.5104.5106.5136. FAP1012.1212.1212-14.1212B	S46.I.T	4	34.925X84. 1	2.385 2.385 6.335 6.335

							
编号 Number	缸径(Φ) Cylinder Diameter(Φ)	外形数据 Overall data	适用车型 Applicable models of automobiles	发动机 Generator	缸数 Number of cylinders	活塞销 Piston Pin	活塞环 Piston ring
BYP2611	87	67.00 32.00  	M30	VG30E. 3.0L	6	21X64.2	1.5 1.5 2.8
BYP11108	98	52.00 31.65-4.2  	ARMADA, PATHFINDER, TITAN, 04-10	5.6LT	8	22X60	1.5 1.5 2.5

							
编号 Number	缸径(Φ) Cylinder Diameter(Φ)	外形数据 Overall data	适用车型 Applicable models of automobiles	发动机 Generator	缸数 Number of cylinders	活塞销 Piston Pin	活塞环 Piston ring
BYP406	84	80.00 37.00-2  	I-MARK.PICKUP	G180Z. 1.8L	4	22×66	2 2 4
BYP443	87	80.00 37.00  	IMPULSE.PICKUP	G200Z. 2.0L	4	22×78	2 2 4
BYP2021	92.6	79.00 36.50  	TROOPER II. PICKUP	4ZE1. 2.6L	4	23X72	1.5 1.5 4
BYP1258	93	50.20 28.15+2.35  	ASCENDER	4.2L LL8	6	23X65	1.2 1.5 2.5





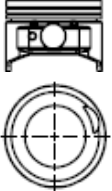
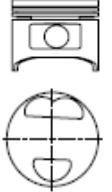
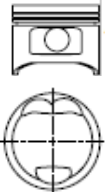



							
编号 Number	缸径(Φ) Cylinder Diameter(Φ)	外形数据 Overall data	适用车型 Applicable models of automobiles	发动机 Generator	缸数 Number of cylinders	活塞销 Piston Pin	活塞环 Piston ring
BYP5242	88	51.47 27.50 	JOURNEY, COMPASS, PATRIOT, PT, CRUISER, AVANGER, CALIBER, 07-10	144CID. 2.4LT	4	21X59	1.2 1.2 2
BYP823	98.4	85.50 40.30-3.2 	COMANCHE.GRAND.CHEROKEE TJ.WAGONEER.WRANGLER	242CID. 4.0L	6	23.65X81	2 2 4.8
BYP3241	98.4	70.30 40.42-3.1 	CHEROKEE.GRAND CHEROKEE JI.WRANGLER	242CID. 4.0L	6	23.65X68.5	1.5 1.5 4







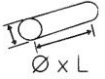

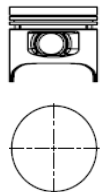
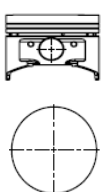
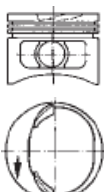
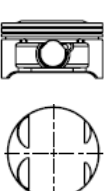
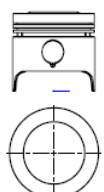
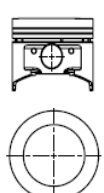
							
编号 Number	缸径(Φ) Cylinder Diameter(Φ)	外形数据 Overall data	适用车型 Applicable models of automobiles	发动机 Generator	缸数 Number of cylinders	活塞销 Piston Pin	活塞环 Piston ring
BY5.8PJS	98.48	120.70 70.10-25.7  	630.730	A 6.354	6	34.925X84. 1	2.385 2.385 6.335 6.335







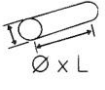

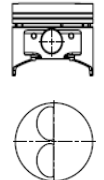
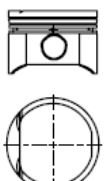
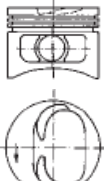
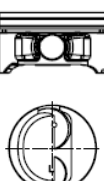
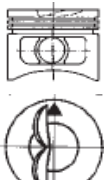
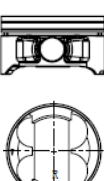
							
编号 Number	缸径(Φ) Cylinder Diameter(Φ)	外形数据 Overall data	适用车型 Applicable models of automobiles	发动机 Generator	缸数 Number of cylinders	活塞销 Piston Pin	活塞环 Piston ring
BY67KIA	67	48.66 24.66-4.1 	PICANTO		4	17X46.5	1.2 1.2 2
BY1.1KIA	71	62.80 32.55 	PRIDE	SOHC 8V	4	20X52	1.2 1.5 3
BY1.3KIA	71	58.00 28.70-2 	PRIDE	B3 SOHC 8V	4	20X52	1.2 1.5 3

LADA(拉达)





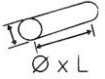

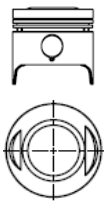
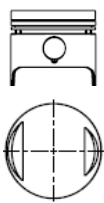

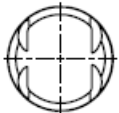







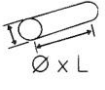

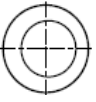
							
编号 Number	缸径(Φ) Cylinder Diameter(Φ)	外形数据 Overall data	适用车型 Applicable models of automobiles	发动机 Generator	缸数 Number of cylinders	活塞销 Piston Pin	活塞环 Piston ring
BY1.2LD	76	77.00 38.00 	JUNIOR.VAZ1500.1200.NOVA VAZ2101.VAZ2102.VAZ2103	1.5 .BA 3 2101	4	22X67	1.5 2 3.95
BY2101LD	76	77.00 38.00 	.VAZ21061.VAZ2105. VAZ2107	1.5 .BA 3 2101	4	22X67	1.5 2 3.95
BY2108LD	76	65.90 37.90 	.VAZ2108.VAZ2109 SAMARA.SHIGULI	21081 1.3	4	22X61.2	1.5 2 3.95
BY11194LD	76.5	45.15 25.65+1.5 	11194		4	18x48	1.2 1.5 2
BY1.3LD	79	77.00 38.00-2 	1600.NIYA1.6 .NOVA1.3 .NOCA1.6	VAZ 2106. 1.3	4	22X67	1.5 2 3.947
BY21011LD	79	77.00 38.00-2 	NOVA. TAIGA .VAZ2015.VAZ2107.VAZ2121	BA 3 2106. VAZ 21011	4	22X67	1.5 2 3.947







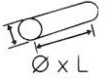

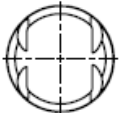



							
编号 Number	缸径(Φ) Cylinder Diameter(Φ)	外形数据 Overall data	适用车型 Applicable models of automobiles	发动机 Generator	缸数 Number of cylinders	活塞销 Piston Pin	活塞环 Piston ring
BY2105LD	79	77.00 38.00 	NOVA. VAZ2015.VAZ2107	1.3 1.6	4	22X67	1.5 2 3.947
BYP1200	79.5	55.00 31.70-1.7 	LARGUS	1.6L	4	20x62	1.5 1.5 2.5
BY21083LD	82	65.90 37.90 	SAMARA.SHIGULI.VAZ2108	1.5	4	22X67	1.5 2 3.947
BY21116LD	82	45.15 25.65-2.8 	21116		4	18x53	1.2 1.5 2
BY21213LD	82	65.90 37.90 	2121.3		4	22x67	1.5 2 3.947
BY21126LD	82.5	45.15 25.65+1.25 	21126		4	18x53	1.2 1.5 2

							
编号 Number	缸径(Φ) Cylinder Diameter(Φ)	外形数据 Overall data	适用车型 Applicable models of automobiles	发动机 Generator	缸数 Number of cylinders	活塞销 Piston Pin	活塞环 Piston ring
BY132F18	84	79.85 38.45+1.6 	BETA	132AB.132B 132BB	4	22X69	1.5 2 3.95
BY132F2	84	77.95 38.45 	BETA.HPE.PRISMA.TREVI	828B	4	22X69	1.5 2 3.95

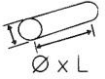







编号 Number	缸径(Φ) Cylinder Diameter(Φ)	外形数据 Overall data	适用车型 Applicable models of automobiles	发动机 Generator	缸数 Number of cylinders	活塞销 Piston Pin	活塞环 Piston ring
BYRV80	80	45.65 22.70-0.53  	FREELANDER	18K4F	4	18X53	1 1.2 2





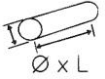

							
编号 Number	缸径(Φ) Cylinder Diameter(Φ)	外形数据 Overall data	适用车型 Applicable models of automobiles	发动机 Generator	缸数 Number of cylinders	活塞销 Piston Pin	活塞环 Piston ring
BY5.8PJS	98.48	120.70 70.10-25.7  	BOXER BX14.25. BX18TF.BX19TF.BX19TA	6.354	6	34.925X84. 1	2.385 2.385 2.385 6.33 6.33

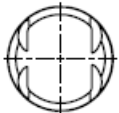
							
编号 Number	缸径(Φ) Cylinder Diameter(Φ)	外形数据 Overall data	适用车型 Applicable models of automobiles	发动机 Generator	缸数 Number of cylinders	活塞销 Piston Pin	活塞环 Piston ring
BYRV80	80	45.65 22.70-0.53  	ELISE.	18K4F	4	18X53	1 1.2 2

							
编号 Number	缸径(Φ) Cylinder Diameter(Φ)	外形数据 Overall data	适用车型 Applicable models of automobiles	发动机 Generator	缸数 Number of cylinders	活塞销 Piston Pin	活塞环 Piston ring
BY3.8PJS	98.48	121.10 70.30-20.8+3.2  	MF175. MF177. MF187. MF487. MF50B. MF575. M 87. MF95. MF 99	AD 4.236	4	34.925X84. 1	2.385 2.385 2.385 6.335
BY5.8PJS	98.48	120.70 70.10-25.7+3.2  	1100.1114.1200.2640	6.354.4	6	34.925X84. 1	3.16 2.385 2.385 6.335 6.335

							
编号 Number	缸径(Φ) Cylinder Diameter(Φ)	外形数据 Overall data	适用车型 Applicable models of automobiles	发动机 Generator	缸数 Number of cylinders	活塞销 Piston Pin	活塞环 Piston ring
BYP802	74	53.90 29.40 	121.	OHV1.3L	4	18.034X64	1.5 1.75 3
BYAC8A	83	53.90 29.90-6.3 	626.MX-6	FP	4	19X58	1.2 1.5 3
BYP2606	92	74.60 36.50-8.7 	B2600.MPV	G6. 2.6L	4	23X63	1.5 1.5 4
BYP816	96	62.45 30.28-2.1 	RANGER	2.5 (153)	4	23.17X66	1.5 1.5 3
BYP3155	100.4	64.60 36.70 	B4000 97-10	4016CC .4.0L	6	24X72	1.6 1.75 3.5



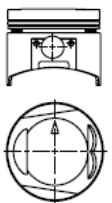
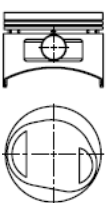
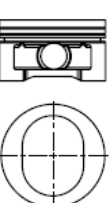









							
编号 Number	缸径(Φ) Cylinder Diameter(Φ)	外形数据 Overall data	适用车型 Applicable models of automobiles	发动机 Generator	缸数 Number of cylinders	活塞销 Piston Pin	活塞环 Piston ring
BYRV80	80	45.65 22.70-0.53  	MGF.MG120. MG135.HATCHBACK	18K4F	4	18X53	1 1.2 2



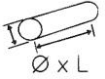

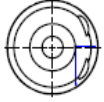
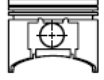
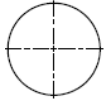
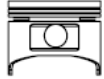
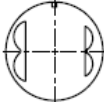

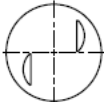
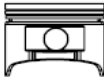

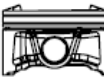
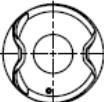





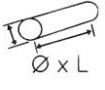

							
编号 Number	缸径(Φ) Cylinder Diameter(Φ)	外形数据 Overall data	适用车型 Applicable models of automobiles	发动机 Generator	缸数 Number of cylinders	活塞销 Piston Pin	活塞环 Piston ring
BY73MI	73	72.00 39.00 			4	19X64	2.5 2 2 4
BYP2044	86.5	67.20 35.00+0.35 	FORKLIFT.PICKUP	4G64	4	22x62	1.2 1.5 3
BYP2023	86.5	72.10 35.50+0.35 	VAN .PICKUP .GALANT	4G64. G64B. 2.4L	4	21x72	1.5 1.5 4
BYP249	91.1	67.80 31.60 	MONTERO.PICKUP	6G72 VG72	6	22x64	1.5 1.5 4
BYP225	93	53.70 31.75-2.4 	VOYAGER,CARAVAN 01-02, LIBERTY 3.7 99-07	201CID. 3.3L	6	22.885X67. 5	1.5 1.5 3

NISSAN(尼桑)





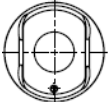







							
编号 Number	缸径(Φ) Cylinder Diameter(Φ)	外形数据 Overall data	适用车型 Applicable models of automobiles	发动机 Generator	缸数 Number of cylinders	活塞销 Piston Pin	活塞环 Piston ring
BYP2599	76	62.35 32.50-8.7  	PRAIRIE .SUNNY .CHERRY	E15 E16I E16S	4	19X62	1.5 1.5 4
BYP2610	76	53.60 29.35-4.7  	BAME.100NX.AIMERA. PRIMERA.SERENA.SUNNY	GA 16DE GA16DS	4	19x52	1.5 1.5 2.8
BY77NS	77	83.00 44.40+10  			4	22X67	1.6 2 4
BY77ZN	77	66.50 40.30-1.65  	MICRA	TUD5	4	23X60	2 1.75 3
BY2.0VG	78	65.50 30.50+2  	CEDRIC.GLORIA. FAIRLADY-Z LAUREL	VG2.0. V6	6	20x57	1.5 1.5 2.8
BYP1200	79.5	55.00 31.70-1.7  	KUBISTAR	1.6L	4	20x62	1.5 1.5 2.5

							
编号 Number	缸径(Φ) Cylinder Diameter(Φ)	外形数据 Overall data	适用车型 Applicable models of automobiles	发动机 Generator	缸数 Number of cylinders	活塞销 Piston Pin	活塞环 Piston ring
BYP1100	80	53.75 29.25-4.6  	ALMERA, SENTRA	QG18DE. 1.8L	4	19X52	1.2 1.2 2.5
BYP615	80.5	65.50 32.50  	DATSUN, ICHIVAN, SAMURAI, SAKURA, GUAYIN	J18. 1.8L	4	21X66.5	1.5 2 4
BYP2620	85	66.70 31.50  	PICKUP.510. 200SX	Z20.Z20S/X. 2.0L	4	21x72	1.5 1.5 4
BYP2611	87	67.00 32.00  	200SX. MAXIMA	VG 30E 3.0L	6	21x64.2	1.5 1.5 2.8
BYP2612	89	68.00 33.60-0.7  	STANZA, PICKUP, ICHIVAN NACIONAL 12 VALV	KA 2.4 E. 2.4L	4	21x66.5	1.5 1.5 2.8
BYP2810	89	58.15 37.15-11.35  	X-TRAIL, ALTIMA 01-07	2.5LT	4	20X57	1.2 1.2 2

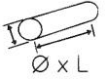
							
编号 Number	缸径(Φ) Cylinder Diameter(Φ)	外形数据 Overall data	适用车型 Applicable models of automobiles	发动机 Generator	缸数 Number of cylinders	活塞销 Piston Pin	活塞环 Piston ring
BYP2811	89	55.00 32.00-3.75  	SENTRA ALTIMA	QR25DE 2.5L	4	20X57	1.2 1.2 2.5
BYP2619	89	68.20 34.00-6.7  	ALTIMA 240SX	KA 2.4 DE. 2.4L	4	21x61	1.5 1.5 2.8
BYP2619U	89	60.90 34.00-6.4  	ALTIMA, URVAN, FRONTIER,	KA 2.4 DE. 2.4LT	4	21X57	1.2 1.2 2.5
BYP13401	95.5	55.00 31.45-1.5  	PATHFINDER. FRONTIER.XTERRA,	VQ40DE 4.0L	6	22X58	1.2 1.2 2.5
BYP11108	98	58.90 31.00  	ARMADA, PATHFINDER, TITAN,	5.6LT	8	22X60	1.5 1.5 2.5

OKTOBAR 14(推土机)



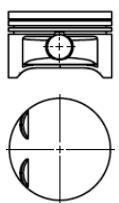
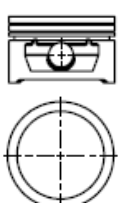





							
编号 Number	缸径(Φ) Cylinder Diameter(Φ)	外形数据 Overall data	适用车型 Applicable models of automobiles	发动机 Generator	缸数 Number of cylinders	活塞销 Piston Pin	活塞环 Piston ring
BY5.8PJS	98.48	120.70 70.10-25.7  	UB 600.RATAR90	6.354	6	34.925X84. 1	2.385 2.385 6.335 6.335







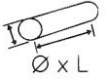

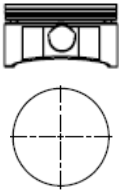
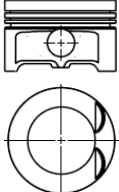
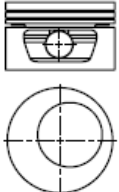
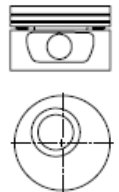
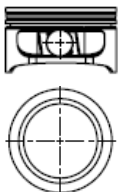
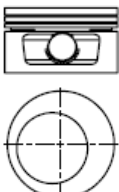
							
编号 Number	缸径(Φ) Cylinder Diameter(Φ)	外形数据 Overall data	适用车型 Applicable models of automobiles	发动机 Generator	缸数 Number of cylinders	活塞销 Piston Pin	活塞环 Piston ring
BY72.5OP	72.5	45.00 24.00 	AGILA. ASTRA. CORSA	X1.2XE. Z1.2XE	4	18X51	1.2 1.5 2
BY73.4POP	73.4	44.00 23.00-1.25 	ASTRA. CORSA.MERIVA	Z.14XEP	4	18X51	1.2 1.2 2
BY73.4ROP	73.4	46.80 25.80-1.6 	ASTRA. ACEO.CORSA.MERIVA	A14XER	4	18X52	1.2 1.2 2
BYP412	77.6	52.50 32.05-3.4 	ASTRA. COMBO. CORSA. KADETT. VECTRA	C14NZ..X14NZ. X14SZ.14NV	4	18X55	1.5 1.5 3
BYP649	79	48.40 28.00+0.4-1.6 	SOHC CHEVYJOY, SWING,MONZA 96-04	1.6 L	4	18X55	1.2 1.5 3
BY79OP	79	48.70 28.00+0.4-2.7 	ASTRA. .KADETT. ASCONA. VECTRA	C1.6NZ. E1.6NZ X1.6SZ. X1.6SZR	4	18x55	1.2 1.5 3







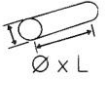

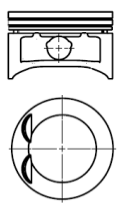
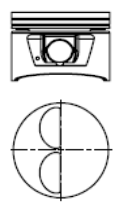
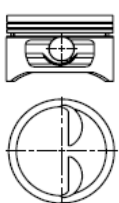





OPEL(欧宝)

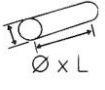

							
编号 Number	缸径(Φ) Cylinder Diameter(Φ)	外形数据 Overall data	适用车型 Applicable models of automobiles	发动机 Generator	缸数 Number of cylinders	活塞销 Piston Pin	活塞环 Piston ring
BY79AOP	79	50.20 27.20 	. ASTRA. MERIVA. VECTRA. ZAFIRA	Y1.6XE. Z1.6XE Z1.6SE	4	18x55	1.2 1.5 2.5
BY79BOP	79	48.00 28.00 	. ASTRA. VECTRA. ZAFIRA. CORSA. TIGRA	X1.6XE. X1.6XEL C1.6XE	4	18x55	1.2 1.5 2.5
BY79POP	79	48.73 26.73 	ASTRA.TWINPORT.MERIVA	Z1.6XEP	4	18X52	1.2 1.2 2
BY79ROP	79	48.70 26.70+1.2 	ASTRA H. ASTRA J.INSIGNIA	Z16XER	4	19X46	1.2 1.2 2
BY79TOP	79	44.50 27.50+0.6 	INSIGNIA	A16LET	4	19X53	1.2 1.2 2
BYP1201	80.5	45.10 24.10-3.8+2.25 	CORSA, TORNADO, MERIVA, VECTRA 02-08	GAS. 1.8L	4	18X57	1.2 1.2 2



							
编号 Number	缸径(Φ) Cylinder Diameter(Φ)	外形数据 Overall data	适用车型 Applicable models of automobiles	发动机 Generator	缸数 Number of cylinders	活塞销 Piston Pin	活塞环 Piston ring
BYP1202	80.5	44.70 24.10 	VECTRA .ASTRA .ZAFIRA. CORSA. MERIVA. SIGNUM. TIGRA	X18X E1. Z1.8XE Z1.8XEL	4	18x57	1.2 1.2 2
BY81.6OP	81.6	50.40 30.40-1.8 	ASTRA. VECTRA	C1.8XE. C1.8XEL X1.8XE	4	21X61.5	1.5 1.5 3
BY84.8OP	84.8	53.65 33.65-5 	ASCONA.ASTRA.KADETT MANTA.OMEGA.VECTRA	1.8 NV 1.8NZ E1.8NV .S 1.8NV	4	21X61.5	1.5 1.5 3
BY84.8AOP	84.8	53.65 33.65-4 	ASCONA.KADETT.VERGASER	1.8 E.1.8S C1.8S .C1.8SV	4	21X61.5	1.5 1.5 3
BYP7911	86	48.90 26.75-0.61 	FRONTERA SPEEDSTER. ASTRA. VECTRA	Z 2.2 SE	4	20x62	1.2 1.5 2.5
BYP9893 BY86OP	86	55.40 30.40-5 	ASTRA. CALIBRA. VECTRA. FRONTERA. KADETT. OMEGA	C2.0 NE. C2.0NZ	4	21x61.5	1.5 1.5 3









							
编号 Number	缸径(Φ) Cylinder Diameter(Φ)	外形数据 Overall data	适用车型 Applicable models of automobiles	发动机 Generator	缸数 Number of cylinders	活塞销 Piston Pin	活塞环 Piston ring
BY86B OP	86	55.40 30.40-5 	ASTRA. CALIBRA. .OMEGA. VECTRA	X2.0XEV. C2.0XEV	4	21×61.5	1.5 1.5 3
BY2.6OP	88.8	69.00 39.20 	OMEGA .SENATOR	C2.6 NE	6	22×65	1.5 1.5 3
BY2.4OP	95	61.00 31.50-2.25 	FRONTERA .OMEGA	C2.4 NE	4	22×65	1.5 1.5 3



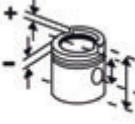



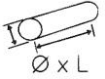

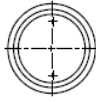







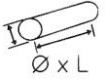

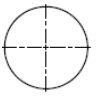
							
编号 Number	缸径(Φ) Cylinder Diameter(Φ)	外形数据 Overall data	适用车型 Applicable models of automobiles	发动机 Generator	缸数 Number of cylinders	活塞销 Piston Pin	活塞环 Piston ring
BY3.8PJS	98.48	121.10 70.30-20.8+3.2  	EINBAUMOTOR	AD 4.236.D39C	4	34.925X84. 1	2.385 2.385 2.385 6.335
BY5.8PJS	98.48	120.70 70.10-25.7+3.2  	EINBAUMOTOR	6.354.2. 6.354.4	6	34.925X84. 1	3.16 2.385 2.385 6.33 6.33
BY5.8PJS	98.48	120.70 70.10-25.7  	EINBAUMOTOR	6.354V	6	34.925X84. 1	2.385 2.385 2.385 6.335 6.335

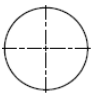
PEUGEOT(标致)



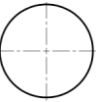

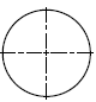

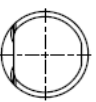



							
编号 Number	缸径(Φ) Cylinder Diameter(Φ)	外形数据 Overall data	适用车型 Applicable models of automobiles	发动机 Generator	缸数 Number of cylinders	活塞销 Piston Pin	活塞环 Piston ring
BYP1413	75	48.93 27.75  	106.206.306.307. PARTNER.RANCH	TU3JPL4.EURO4	4	17.974x55	1.5 1.5 2.5
BY1.4FK	75	64.00 40.50-1  	106.205.306.309.405.PARTNER	TU3A.K2D	4	19.5x62	1.75 2 3
BY77ZN	77	66.50 40.30  	106	TUD5	4	23X60	2 1.75 3
BYP1414	78.5	50.15 32.35+0.15  	106.206.307	TU5JP. 1.6L	4	19.5X57	1.2 1.5 2.5
BY83PZ	83	56.30 33.30-1.00  	306.406	UX 7 JP 4	4	22x62	1.5 1.5 3
BY84PZ	84	69.10 37.00+1.1  	504.J5.J7	XM7 .XM 7 P	4	23x70	1.5 2 4







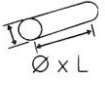

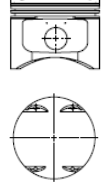
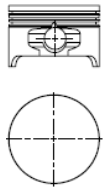
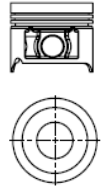

							
编号 Number	缸径(Φ) Cylinder Diameter(Φ)	外形数据 Overall data	适用车型 Applicable models of automobiles	发动机 Generator	缸数 Number of cylinders	活塞销 Piston Pin	活塞环 Piston ring
BY88PZ	88	71.50 37.85-0.65  	J5 2.0 504 2.0 505 2.0	XN1 . XN 1 T	4	23×74	1.5 2 4









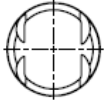

							
编号 Number	缸径(Φ) Cylinder Diameter(Φ)	外形数据 Overall data	适用车型 Applicable models of automobiles	发动机 Generator	缸数 Number of cylinders	活塞销 Piston Pin	活塞环 Piston ring
BY58RN	58	64.00 30.00  	R1123、R2106、R1221 R4、R5、R6	800 01.02.10.A7	4	16×50	1.75 2 3.5
BY70RN	70	68.00 40.00  	R10.R11.R4.R5.R6.R8.R9.T800. R2134.R2370.R2420.R2430.R2132. R1136.R1132	688.01-03.10-12 C1E.752.754.756. 760.762.764.792. C7	4	18×62	1.75 2 3.5
BY73RN	73	62.70 37.50+0.20  	R5.R6.R10.R15.R12.R1170.R1192. R1337.R12126.R2136.R2137.R122 4.R1330.	810.01-03.10 B7.C7.F7	4	20×62	1.75 2 4
BY75.8RN	75.8	52.60 31.7  	CLIO.EXPRESS.KANGOO .R19.R7J	E6J.E7J.R7J	4	19×60	1.5 1.75 3
BY76RN	76	62.60 37.60  	FUEGO.R18.T1000.T550.T800. EXPRESS.R5 .R9.R12.R11.R19	847.20.21.C1J.78 0.C16.J.L.17.C2J. 782.784.N18.C3J 700.702.710.720. 760.762.A710.J.J. 15	4	20×64	1.75 2 4
BYP1200	79.5	55.00 31.70-1.7  	CLIOII.KANGOO.LAGUNA.LOGAN. MEGANEI.MEGANE II.MODUS.SCENIC	1.6L	4	20×62	1.5 1.5 2.5

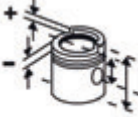



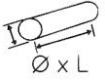



RENAULT(雷诺)







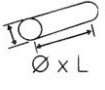

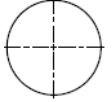





							
编号 Number	缸径(Φ) Cylinder Diameter(Φ)	外形数据 Overall data	适用车型 Applicable models of automobiles	发动机 Generator	缸数 Number of cylinders	活塞销 Piston Pin	活塞环 Piston ring
BYRN79.5LH01	79.5	64.50 37.20-1.2-2.08 	CLIO.MEGANE. SYMBOL.THALIA	K4J.713	4	20x62	1.2 1.5 2.5
BYRN79.5LH02	79.5	52.85 28.30 	SANBERO.LOGAN		4	19x62	1.5 1.5 2.5
BY81RN	81	70.10 44.10-13.4 	R19 TXI	F3N 746 KAT	4	21x57	1.75 2 3



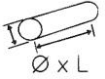

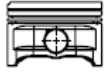
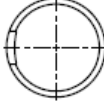
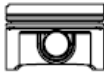

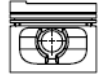
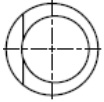
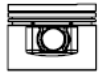
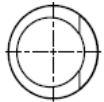
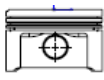
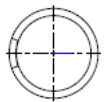

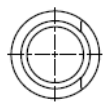

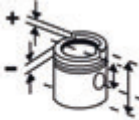

							
编号 Number	缸径(Φ) Cylinder Diameter(Φ)	外形数据 Overall data	适用车型 Applicable models of automobiles	发动机 Generator	缸数 Number of cylinders	活塞销 Piston Pin	活塞环 Piston ring
BYRV75	75	46.79 23.84-1.43  	100.200.400HATCHBACK	14K2A.14K2D 14K2F	4	18X48	1 1.2 2
BYRV80	80	45.65 22.70-0.53  	25.45.75.200.400.CADRIOLET	18K4F.16K4F	4	18X53	1 1.2 2



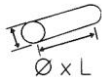









							
编号 Number	缸径(Φ) Cylinder Diameter(Φ)	外形数据 Overall data	适用车型 Applicable models of automobiles	发动机 Generator	缸数 Number of cylinders	活塞销 Piston Pin	活塞环 Piston ring
BY3.8PJS	98.48	120.70 70.10-25.7  	560EL 560K 560L 560N 560UL 610EL 610K 610L 610N 610UL GL750M	6.354	6	34.925X84. 1	2.385 2.385 6.335 6.335

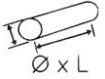

							
编号 Number	缸径(Φ) Cylinder Diameter(Φ)	外形数据 Overall data	适用车型 Applicable models of automobiles	发动机 Generator	缸数 Number of cylinders	活塞销 Piston Pin	活塞环 Piston ring
BYP1202	80.5	44.70 24.10  	HUB 88.2MM. 4VENTILE. 9-3	X18X E1	4	18x57	1.2 1.2 2

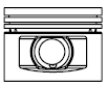
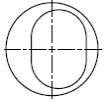
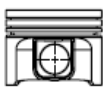
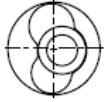
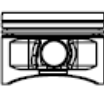

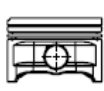
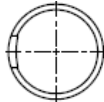
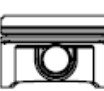

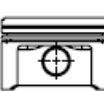
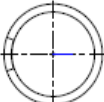



							
编号 Number	缸径(Φ) Cylinder Diameter(Φ)	外形数据 Overall data	适用车型 Applicable models of automobiles	发动机 Generator	缸数 Number of cylinders	活塞销 Piston Pin	活塞环 Piston ring
BY133F08	65	63.00 32.50  	133	DB-10. DG	4	20X54	1.75 2 3.94
BY1.3GIF	75	69.87 42.87-16.6  	CORDOBA .IBIZA	2G .1.3	4	20X54	1.75 2 3
BY1.4GIF	75	52.02 34.52-15.2  	CORDOBA .IBIZA	ABD	4	17X48	1.5 1.5 2.5
BY1.6GIF	76.5	54.00 32.00-8.7  	CORDOBA. IBIZA	ABU	4	17X52	1.5 1.5 2.5
BYJDCY	79.5	60.70 39.80-17.75-1  	CORDOBA. IBIZA. INCA. LEON. TOLEDO	DIESEL	4 1.2/3.4	24X59	1.75 2 3
BYP714 STN1.8	81	62.50 32.20+1.3-8.1  	TOLEDO.I(1L)	AAM.ADF JN RP	4	20x57	1.5 1.75 3



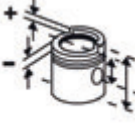



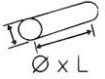

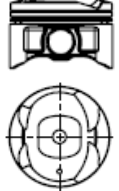
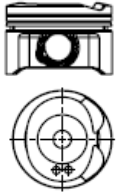
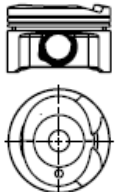
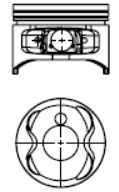
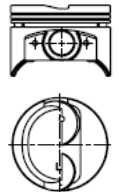
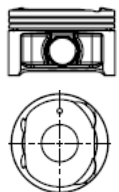
							
编号 Number	缸径(Φ) Cylinder Diameter(Φ)	外形数据 Overall data	适用车型 Applicable models of automobiles	发动机 Generator	缸数 Number of cylinders	活塞销 Piston Pin	活塞环 Piston ring
BYP712 B5/1.8T	81	53.70 32.70-1.9  	LEON.TOLEDO.IBIZA	AJQ	4	19X50	1.5 1.75 2
BYP20018 AD200/1.8T	81	53.70 32.70-1.5  	IBIZA.ALHAMBRA. INCA.CORDOBA	AEB	4	20x59	1.5 1.75 2
BY1.6NJD	81	66.80 35.60+2.2-2.3  	IBIZA.TOLEDO. LEON.CORDOBA	1.6	4	20x57	1.5 1.75 3
BY2.2AD	81	62.30 32.20+1.1-4.6  	IBIZA. TOLEDO.CORDOBA	1.8 ABS. KT.PB.PF	4	20x57	1.5 1.75 3
BY1.8TA6	81	53.70 32.70-1.9  	IBIZA.LEON.TOLEDO	AJQ	4	19x50	1.5 1.75 2
BYP20019 AD2.0	82.5	51.79 30.90+0.89-5  	IBIZA.LEON.TOLEDO	2E.2.0	4	21x56	1.2 1.5 2





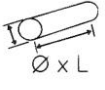

							
编号 Number	缸径(Φ) Cylinder Diameter(Φ)	外形数据 Overall data	适用车型 Applicable models of automobiles	发动机 Generator	缸数 Number of cylinders	活塞销 Piston Pin	活塞环 Piston ring
BY132F18	84	79.85 38.45+1.6  	EINBAUMOTOR	132AB.132B. 132BB	4	22X69	1.5 2 3.95
BY132F2	84	77.95 38.45  	EINBAUMOTOR	131C	4	22X69	1.5 2 3.95

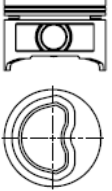
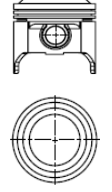





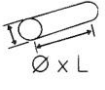

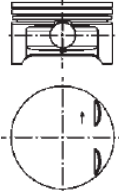
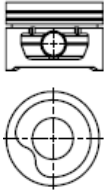
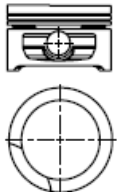
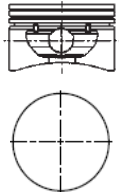
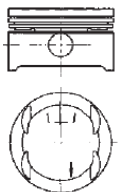
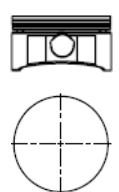
							
编号 Number	缸径(Φ) Cylinder Diameter(Φ)	外形数据 Overall data	适用车型 Applicable models of automobiles	发动机 Generator	缸数 Number of cylinders	活塞销 Piston Pin	活塞环 Piston ring
BY75.5SKD	75.5	57.35 34.35-1.75  	FAVORIT 135 .FAVORIT 135i	742.135 781.135. 781.135L	4	20x54	1.5 1.5 3
BYJDCY	79.5	60.70 39.80-17.75-1  	FABIA. OCTAVIA	AGP.AQM.ASY	4	24X59	1.75 2 3
BY5VJD	81	57.00 32.70-0.6  	OCTAVIA	AHP 5V	4	20x59	1.5 1.75 2
BYP712 B5/1.8T	81	53.70 32.70-1.9  	OCTAVIA、SUPERB	AJQ	4	19x50	1.5 1.75 2
BYP20018 AD200/1.8T	81	53.70 32.70-1.5  	OCTAVIA	AEB	4	20x59	1.5 1.75 2
BY1.8TA6	81	53.70 32.70-1.9  	OCTAVIA、SUPERB	AJQ	4	19x50	1.5 1.75 2

							
编号 Number	缸径(Φ) Cylinder Diameter(Φ)	外形数据 Overall data	适用车型 Applicable models of automobiles	发动机 Generator	缸数 Number of cylinders	活塞销 Piston Pin	活塞环 Piston ring
BY465LM	65	52.50 25.50  			3	16×49.50	1.2 1.5 2.5
BY72ZN	72	55.00 28.00  	PET		4	17×61	1.2 1.5 2.8
BYP20103	84	58.95 29.39-4.85  	SIDEKICK.SPORT.ESTEEM	G18K. 1.8L	4	21X59	1.2 1.5 2.5
BYP20103	84	58.95 29.39-4.85  	GRAND.VITARA.	H25A. 2.5L	6	21X59	1.2 1.5 2.5





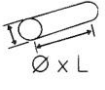

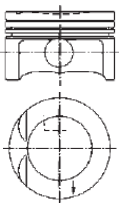
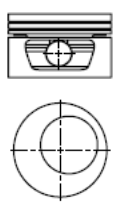
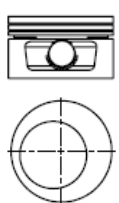
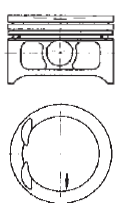









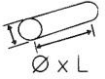

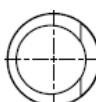
							
编号 Number	缸径(Φ) Cylinder Diameter(Φ)	外形数据 Overall data	适用车型 Applicable models of automobiles	发动机 Generator	缸数 Number of cylinders	活塞销 Piston Pin	活塞环 Piston ring
BYP2665	75	49.80 30.70 	ECHO.YARIS. SCION XA,XB 04-10	1NZFE. 1.5L	4	18X53	1.2 1.2 2
BYP1914	79	51.70 32.20 	COROLLA.CELICA.GT	1ZZFE. 1.8L	4	20X50	1.2 1.2 3
BYP1027	79	51.70 32.20 	COROLLA.CELICA.GT	1ZZFE. 1.8L	4	20X50	1.2 1.2 3
BY87.1CMR	87.1	63.00 32.50-4.8 	CAMRY 2.2i .CAMRY SOLARA2.2 CELICA2.2i. MR2 2.2i	5S FE	4	22X66	1.5 1.5 4
BYP2666	87.5	63.00 33.65 	PICKUP .4RUNNER	3VZE 3.0L	6	21X63	1.5 1.5 4
BYP1026	88.5	55.70 35.70 	HIGHLANDER.CAMRY. RAV4 SOLARA 01-08	2AZFE. 2.4LT	4	22X56	1.2 1.2 2

							
编号 Number	缸径(Φ) Cylinder Diameter(Φ)	外形数据 Overall data	适用车型 Applicable models of automobiles	发动机 Generator	缸数 Number of cylinders	活塞销 Piston Pin	活塞环 Piston ring
BY4YJB	91	65.0 35.00 	HI-ACE.MODEL F.HI-LUX	4Y	4	22x66	1.5 1.5 4
BYP9023	92	92.30 39.00 	CELICA. CORONA.VAN WAGON	22R	4	22x75	2 2.5 4





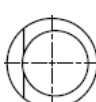



							
编号 Number	缸径(Φ) Cylinder Diameter(Φ)	外形数据 Overall data	适用车型 Applicable models of automobiles	发动机 Generator	缸数 Number of cylinders	活塞销 Piston Pin	活塞环 Piston ring
BY72.5OP	72.5	45.00 24.00 	AGILA. ASTRA. CORSA	X1.2XE. Z1.2XE	4	18X51	1.2 1.5 2
BYP412	77.6	52.50 32.05-3.4 	COMBO.CORSA.NOVA	C14NZ..X14NZ. X14SZ.14NV	4	18X55	1.5 1.5 3
BY79OP	79	48.70 28.00+0.4-2.7 	ASTRA.CAVALIER.VECTRA	C1.6NZ. E1.6NZ X1.6SZR	4	18x55	1.2 1.5 3
BY79AOP	79	50.20 27.20 	VECTRA . ASTRA. MERIVA. COMBO. ZAFIRA. CORSA	Y1.6XE. Z1.6XE Z1.6SE	4	18x55	1.2 1.5 2.5
BY79BOP	79	50.20 27.20 	. ASTRA. VECTRA. ZAFIRA. CORSA. TIGRA	X1.6XE. X1.6XEL C1.6XE	4	18x55	1.2 1.5 2.5
BYP1202	80.5	44.70 24.10 	ASTRA. ZAFIRA.	X1.8X E1. Z1.8XE	4	18x57	1.2 1.2 2

							
编号 Number	缸径(Φ) Cylinder Diameter(Φ)	外形数据 Overall data	适用车型 Applicable models of automobiles	发动机 Generator	缸数 Number of cylinders	活塞销 Piston Pin	活塞环 Piston ring
BY81.6OP	81.6	50.40 30.40-1.8 	ASTRA. VECTRA	C1.8XE. C1.8XEL X1.8XE	4	21X61.5	1.5 1.5 3
BY84.8OP	84.8	53.65 33.65 	CARLTON.ASTRA. BELMONT.CAVLIER	1.8 NV 1.8NZ E1.8NV .S 1.8NV	4	21X61.5	1.5 1.5 3
BYP9893 BY86OP	86	55.40 30.40-5 	ASTRA. CALIBRA. BELMONT. FRONTERA.	C2.0 NE.	4	21x61.5	1.5 1.5 3
BY86B OP	86	55.40 30.40-5 	ASTRA. CALIBRA. .OMEGA. VECTRA	X2.0XEV. C2.0XEV	4	21x61.5	1.5 1.5 3





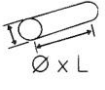

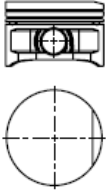
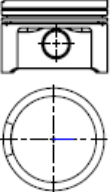
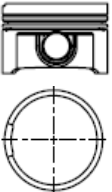
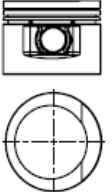
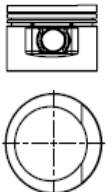
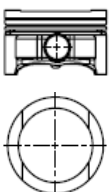

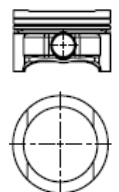
							
编号 Number	缸径(Φ) Cylinder Diameter(Φ)	外形数据 Overall data	适用车型 Applicable models of automobiles	发动机 Generator	缸数 Number of cylinders	活塞销 Piston Pin	活塞环 Piston ring
BYSP590	67.11	41.77 23.27-1.2  	1000	AT.FLEX. 1.0L	4	17X39	1 1 1.5
BY1.3GIF	75	69.87 42.87-16.6  	GOLF. POLO. JETTA	2G AAV HK HW MH NU NZ	4	20X54	1.75 2 3
BY1.4GIF	75	52.02 34.52-15.2  	GOLF. VENTO	ABD	4	17X48	1.5 1.5 2.5
BY1.6GIF	76.5	54.00 32.00-8.7  	GOLF. VENTO	ABU	4	17X52	1.5 1.5 2.5
BYP2014	76.5	47.25 28.70-6.8  	GOLF..POLO.FOX	EA111.FLEX.1.6L	4	17X52	1.2 1.5 2.5
BYJDCY	79.5	60.70 39.80-17.75-1  	JETTA. BORA. GOLF. CADDY. POLO. FOX. SPACEFOX	AGP.AQM.ASY	4 1.2/3.4	24X59	1.75 2 3



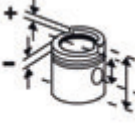



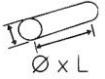

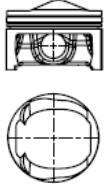
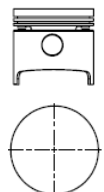
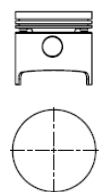
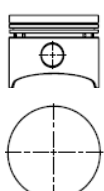
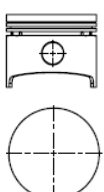
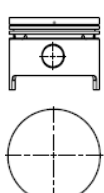
							
编号 Number	缸径(Φ) Cylinder Diameter(Φ)	外形数据 Overall data	适用车型 Applicable models of automobiles	发动机 Generator	缸数 Number of cylinders	活塞销 Piston Pin	活塞环 Piston ring
BYP714 STN1.8	81	62.50 32.20+1.3-8.1  	GOLF.JETTA.PASSAT.SANTANA. VENTO.026.2INDUSTRIEMOTOR. QUANTUM	AAM.ADF.JN.RP	4	20x57	1.5 1.75 3
BYP714 STN1.8	81	62.50 32.20+1.3-8.1  	PASSAT .QUANTNM (USA)	JT.KX	5	20x57	1.5 1.75 3
BYP20105	81	64.35 38.25-4.6  	CALIFORNIA T4	ACU .AET APL .AVT	5	24X56	1.75 2 3
BYP713	81	57.30 32.20+1.3-3.9  	APOS.1998.GOL/PARATI/ SAVEIRO/POLO.CLASSIC.99	AP.1.8MI	4	20X57	1.2 1.5 2
BY1.6NJD	81	66.80 35.60+2.2-2.3  	GOLF.PASSAT.JETTA.SANTANA	ABN .DT .EW .EZ. EZA.PN JU .RF	4	20x57	1.5 1.75 3
BY1.6BR	81	57.00 32.70+1.28  	BORA	1.6	4	20x59	1.5 1.75 2

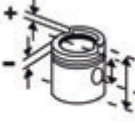







							
编号 Number	缸径(Φ) Cylinder Diameter(Φ)	外形数据 Overall data	适用车型 Applicable models of automobiles	发动机 Generator	缸数 Number of cylinders	活塞销 Piston Pin	活塞环 Piston ring
BY1.8LSJ	81	53.50 32.50+1-6.5  	SANTANA 世纪新秀	1.8L	4	20x57	1.5 1.75 3
BY1.6L99	81	51.60 30.60+2.2-1  	SANTANA、99 新秀	1.6L	4	20x57	1.5 1.75 2
BYP712 B5/1.8T	81	53.70 32.70-1.9  	BORA、PASSAT .NEW BEETLE	1.8T	4	19x50	1.5 1.75 2
BY2VJD	81	53.00 32.00+0.7-3.85  	JETTA. ATI.GIX	1.6L 2V	4	20x57	1.5 1.75 2
BY2000STN	81	53.50 32.50+0.7-6.85  	SANTANA.2000.GLS.GLI.GSI	1.8L	4	20x57	1.5 1.75 3
BY5VJD	81	57.00 32.70-0.6  	JETTA . GX .AT	AHP 5V	4	20x59	1.5 1.75 2

							
编号 Number	缸径(Φ) Cylinder Diameter(Φ)	外形数据 Overall data	适用车型 Applicable models of automobiles	发动机 Generator	缸数 Number of cylinders	活塞销 Piston Pin	活塞环 Piston ring
BY1.8B5	81	52.55 32.55 	BORA、PASSAT GLI.GSI	ANQ	4	20x52	1.5 1.75 2
BY1.8TA6	81	53.70 32.70-1.9 	PASSAT. NEW BEETLE	AJQ	4	19X50	1.5 1.75 2
BYP20018 AD200/1.8T	81	53.70 32.70-1.5 	PASSAT. NEW BEETLE	AEB	4	20x59	1.5 1.75 2
BY2.2AD	81	62.30 32.20+1.1-4.6 	GOLF.JETTA.PASSAT.VENTO. SANTANA.SCIROCCO	1P.2H.ABS.ADZ. GU.GX.HV.JV. DS.DX.DZ.EV.GZ. KT.HTJH.PB	4	20x57	1.5 1.75 3
BY2.2AD	81	62.30 32.20+1.1-4.6 	PASSAT	KV	5	20x57	1.5 1.75 3
BY3000STN	81	53.50 32.50+0.7-5.35 	STN3000		4	19x42	1.5 1.75 3

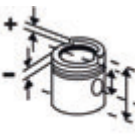



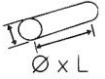

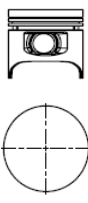
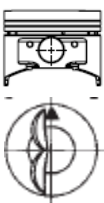
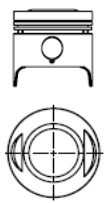

							
编号 Number	缸径(Φ) Cylinder Diameter(Φ)	外形数据 Overall data	适用车型 Applicable models of automobiles	发动机 Generator	缸数 Number of cylinders	活塞销 Piston Pin	活塞环 Piston ring
BYSTN3000G	81	50.00 29.00 	STN3000G		4	19×42	3 3
BYSTN3000G6	81.02	51.00 30.00 	STN3000G6		4	19×42	6 3
BYSTN2000G6	81.02	59.70 38.70 	STN2000G6		4	20×57	6 2.5
BY2.0NAD	82.5	51.79 30.90+0.89-7.2 	PASSAT. VARIANT	AAE ABT ADW	4	21×56	1.2 1.5 2
BYP20017 B52.0	82.5	50.30 29.30+0.7-5.7 	PASSAT .GOLF.BORA. NEW.BEETLE	APK. 2.0L	4	19×42	1.2 1.5 2
BYP20019 AD2.0	82.5	51.79 30.90+0.89-5 	PASSAT.GOLF.VENTO. CORRADO	2E	4	21×56	1.2 1.5 2

							
编号 Number	缸径(Φ) Cylinder Diameter(Φ)	外形数据 Overall data	适用车型 Applicable models of automobiles	发动机 Generator	缸数 Number of cylinders	活塞销 Piston Pin	活塞环 Piston ring
BY3.0AD	84.5	51.50 30.40 	TOUAREG	D12 D19	6	22X59	1.2 1.5 2
BY85.5VW	85.5	82.50 39.40 	GAS.REFRIGERADO.AR. NEW.BEETLE	311.AR1.6	4	22x72	2 2 5
BY87VW	87	82.50 39.40 	1600	311	4	22x72	2 2 5
BY90.5VW	90.5	72.10 39.60 	GAS.REFRIGERADO.AR. NEW.BEETLE	AR. 1.8L	4	22X75	1.5 2 4
BY92VW	92	74.40 39.60 	GAS.REFRIGERADO.AR. NEW.BEETLE	AR. 1.8L	4	22X75	1.5 2 4
BY94BVW	94	74.40 39.60 	GAS.REFRIGERADO.AR. NEW.BEETLE	AR. 1.9L	4	22X75	1.5 2 4





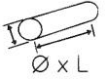

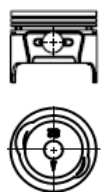
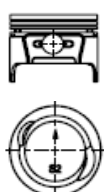
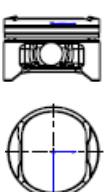
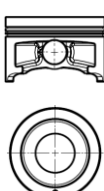
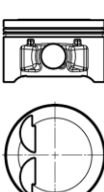
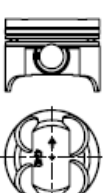

							
编号 Number	缸径(Φ) Cylinder Diameter(Φ)	外形数据 Overall data	适用车型 Applicable models of automobiles	发动机 Generator	缸数 Number of cylinders	活塞销 Piston Pin	活塞环 Piston ring
BY70RN	70	68.00 40.00  	66DL	B10E	4	18x62	1.75 2 3.5
BY73RN	73	62.70 37.50+0.20  	66 DL	B13E	4	20x62	1.75 2 4
BY76RN	76	62.60 37.60  	340-360. 343.344.345	B14 B14OE	4	20x64	1.75 2 4
BY81RN	81	70.10 44.10-13.4  	440GL .GLE .GLT .460GL GLE1.7 .480ES1.7	B18 EP KAT B18 FP KAT	4	21x57	1.75 2 3

							
编号 Number	缸径(Φ) Cylinder Diameter(Φ)	外形数据 Overall data	适用车型 Applicable models of automobiles	发动机 Generator	缸数 Number of cylinders	活塞销 Piston Pin	活塞环 Piston ring
BY1.2LD	76	77.00 38.00 	VAZ101.102.2101	1.5 .BA 3 2101	4	22X67	1.5 2 3.95
BY128F11	80	77.30 34.70+0.6 	101.1100.YUGO55	128 A.000 128 A.064	4	22X71	1.5 2 3.947
BY132F18	84	79.85 38.45+1.6 	132	132AB.132B. 132BB	4	22X69	1.5 2 3.95

AUTO(微型车)



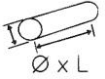

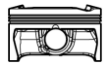
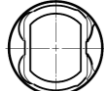



							
编号 Number	缸径(Φ) Cylinder Diameter(Φ)	外形数据 Overall data	适用车型 Applicable models of automobiles	发动机 Generator	缸数 Number of cylinders	活塞销 Piston Pin	活塞环 Piston ring
BY465Q1	65.5	55.00 24.55-2 	长安 五菱	465Q1	4	16X53	1.5 1.5 2.8
BY465Q5	66	54.10 23.60-3 	长安 五菱	465Q1-E	4	16X53	1.5 1.5 2.8
BYB12D	69.7	46.00 25.95-3.7 	五菱荣光 鸿途	B12	4	17X53	1.2 1.2 2
BYDK13	73	47.90 26.00-3.5 	长安 五菱	DK13	4	18X49	1 1.2 2
BY473	73	44.80 26.2+0.6 	长安 五菱 小康	473	4	18X47	1 1.2 2
BY474Q	74	56.10 29.10-2 	长安 五菱 羚羊 奔奔 小康	474Q	4	19X62	1.2 1.2 2.5

AUTO(微型车)





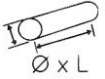

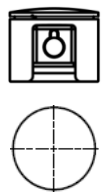
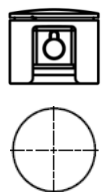
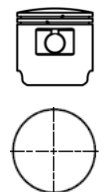
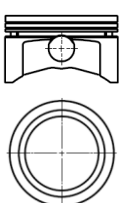









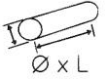

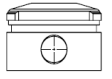

							
编号 Number	缸径(Φ) Cylinder Diameter(Φ)	外形数据 Overall data	适用车型 Applicable models of automobiles	发动机 Generator	缸数 Number of cylinders	活塞销 Piston Pin	活塞环 Piston ring
BYB15D	74.7	43.50 25.50+2.7  	长安 五菱 羚羊 奔奔 小康	B15D	4	18X48	1.2 1.2 2

							
编号 Number	缸径(Φ) Cylinder Diameter(Φ)	外形数据 Overall data	适用车型 Applicable models of automobiles	发动机 Generator	缸数 Number of cylinders	活塞销 Piston Pin	活塞环 Piston ring
BY2.0VG	78	65.50 30.50+2  	世纪星	VG2.0	6	20×57	1.5 1.5 2.8
BY488HC	87.5	71.25 40.45-1.6  	E 7180 化长	488	4	23×70	1.5 1.5 4
BY488DC	87.5	71.25 40.45-1.6  	E 7180 电长	488	4	23X70	1.5 1.5 4
BY488HD	87.5	56.00 34.50-3.5  	化短	488	4	23x61.5	1.5 1.5 4
BY488DD	87.5	56.00 34.50-3.5  	电短	488	4	23x61.5	1.5 1.5 4













MODEL AIRCRAFT(航模)

							
编号 Number	缸径(Φ) Cylinder Diameter(Φ)	外形数据 Overall data	适用车型 Applicable models of automobiles	发动机 Generator	缸数 Number of cylinders	活塞销 Piston Pin	活塞环 Piston ring
DLE61	47	37.00 18.50+2.2 	航模	DLE61	1	10x30	1.5 T
DLE120H	47	39.00 19.00+2.20 	航模	DLE120H	1	11x30	1.5 T
DLE106	52	53.00 21.00+3.85 	航模	DLE106	1	13x40	1.5 1.5 T
DLE3000	110	65.00 32.00-3.37 	航模	DLE3Q	4	25x83	1.5 1.5 4.5

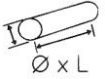

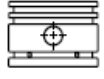
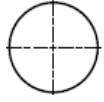
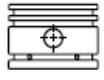
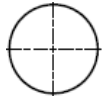
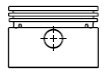
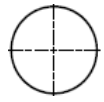
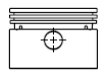
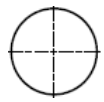
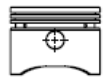

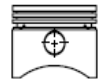











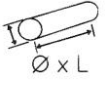

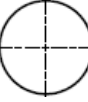
COMPRESSOR(压缩机)

							
编号 Number	缸径(Φ) Cylinder Diameter(Φ)	外形数据 Overall data	适用车型 Applicable models of automobiles	发动机 Generator	缸数 Number of cylinders	活塞销 Piston Pin	活塞环 Piston ring
BYMC18L	46	80.00 52.00  	COMPRESSOR	MC18L	1	20X36	2.5 2.5 2.5 4
BYMC32L	50	80.00 52.00  	COMPRESSOR	MC32L	1	20X40	2.5 2.5 2.5 4
BYCT125	55	38.65 26.50  	COMPRESSOR	压缩机	1	15X46.5	4 2.7
BYBF63.5A	63.5	59.50 26.85  	COMPRESSOR BENDIX MWM.FIAT.FNM.PERKINS. CUMMINS	TU-FLO50	1	13.49X56.7	2.38 2.38 2.38 2.38 2.38
BYBF63.5B	63.5	59.50 26.85  	COMPRESSOR KOMPRESSOR2 APPLIKATION LUFTPRESSER	TU-FLO.500	1	13.49X56	2.38 2.38 2.38 3.16 3.16
BYBF66.7	66.7	46.05 23.85  	COMPRESSOR VOLKSWAGEN ANEIS DELIIVERY	OM	1	15.87X50.8	2 2 3









COMPRESSOR(压缩机)

							
编号 Number	缸径(Φ) Cylinder Diameter(Φ)	外形数据 Overall data	适用车型 Applicable models of automobiles	发动机 Generator	缸数 Number of cylinders	活塞销 Piston Pin	活塞环 Piston ring
BYCI1657	69.85	49.78 26.30  	COMPRESSOR VARGA MODELO.EL1300/1600	OM	2	14.28X61.5	4.76 4.76 4.76
BYBF1657	69.85	49.78 26.30  	COMPRESSOR VARGA MODELO.EL1300/1600	OM	2	13.49X61.5	4.76 4.76 4.76
BYCI1749	69.85	49.78 26.30  	COMPRESSOR VARGA EL-1600A.PARTIR.DE2000	OM	2	14.28X61.5	2 2 4.76
BYBF1749	69.85	49.78 26.30  	COMPRESSOR VARGA EL-1600A.PARTIR.DE2000	OM	2	14.28X61.5	2.38 2.38 4.76
BYBF75	75	57.50 27.80  	COMPRESSOR KNORR	OM366.LK15	1	14.98X50	2. 2. 4
BYBF75A	75	60.00 31.00  	COMPRESSOR KNORR	OM366.LK15	1	18X63	2 2 4





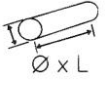

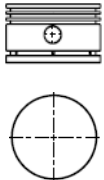
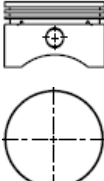
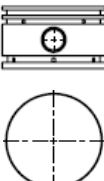
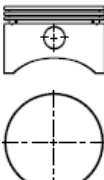
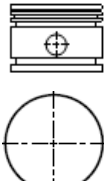
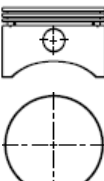

COMPRESSOR(压缩机)

							
编号 Number	缸径(Φ) Cylinder Diameter(Φ)	外形数据 Overall data	适用车型 Applicable models of automobiles	发动机 Generator	缸数 Number of cylinders	活塞销 Piston Pin	活塞环 Piston ring
BYBF 75B	75	60.00 31.00  	COMPRESSOR .MOTORES MBB	OM366.LK15	1	18X63	2 2 2 4
BYBF 75C	75	52.78 32.15  	COMPRESSOR WASSERGEKUHLT APPLIKATION.LUFTPRESSER	15W37.WB31 WB15	1	15.87X60.3	2.38 2.38 3.94
BYRL75	75	60.00 31.00  	COMPRESSOR KNORR	OM366.LK15	1	18X63	2 2 3.5
BYPI 75	75	60.00 31.00  	COMPRESSOR MERCEDES-BENZ .MOTORES MBB	OM366.LK15	1	18X63	2.5 2.5 2.5 4
BYPI 77	77	59.00 30.00  	COMPRESSOR MERCEDES-BENZ KOMPRESSOR EINBANMOTOR.PARTIR DE MOTOR	OM312 OM321 OM352 OM352A	1	16.015X66	2.5 2.5 2.5 4
BYBF80A	80	64.00 31.00  	COMPRESSOR	OM	1	18X63	2.5 2.5 4





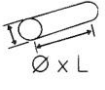

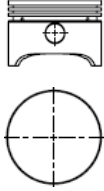
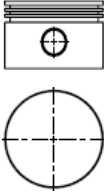
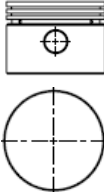
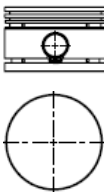
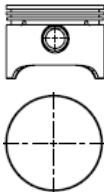
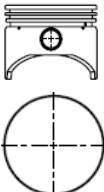
COMPRESSOR(压缩机)

							
编号 Number	缸径(Φ) Cylinder Diameter(Φ)	外形数据 Overall data	适用车型 Applicable models of automobiles	发动机 Generator	缸数 Number of cylinders	活塞销 Piston Pin	活塞环 Piston ring
BYBF80B	80	49.90 26.05 	COMPRESSOR HOLSET	OM	1	14.28X70	3 3 4
BYBF82A	82	51.80 28.50 	COMPRESSOR ANTIGO	OM	1	14X72	2.5 2.5 4
BYBF82B	82	48.80 26.23 	COMPRESSOR VARGA EL1030/VW6.90/7.90	OM	1	16.36X59	4 4 5
BYPI 85	85	59.00 33.32 	COMPRESSOR	OM	1	19.05X60	2 2 4
BYBF85.5	85.72	61.80 36.45 	COMPRESSOR	BX2150	1	19.05X81	2.38 2.38 4.76 4.76
BYBF86	86	57.00 26.60 	COMPRESSOR	OM	1	18X71	2 2 3

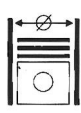
COMPRESSOR(压缩机)



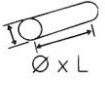

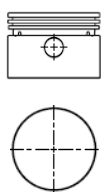
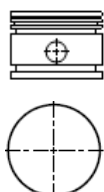
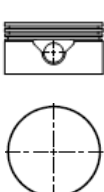
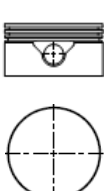
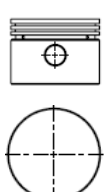
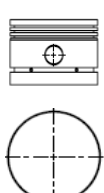





							
编号 Number	缸径(Φ) Cylinder Diameter(Φ)	外形数据 Overall data	适用车型 Applicable models of automobiles	发动机 Generator	缸数 Number of cylinders	活塞销 Piston Pin	活塞环 Piston ring
BYPI88	88	62.40 31.50 	COMPRESSOR MWM229-6CIL.VW11130/11140 FORDF1200/F1400	OM.LK38	1	18X63	2.5 2.5 4
BYPI90B	90	57.50 35.00 	COMPRESSOR MERCEDES-BENZ EINBANMOTOR	OM401.402.403. 404.409.421. 422.423.424.	1	20X60	2.5 2.5 4
BYPI90	90	67.00 37.00 	COMPRESSOR WESTINGHOUSE/WABCO 4/1010-4.1012-4.1026-4 1034-4.1043-4.1510	OM.411	1	20X60	2.5 2.5 4
CA112	90	59.00 35.00 	COMPRESSOR	OM	1	20X60	2.5 2.5 4 4
BYBF92	92	68.00 31.00 	COMPRESSOR	OM	1	18X63	2.5 2.5 4
BYBF92.1	92.08	73.30 33.55 	COMPRESSOR HOLSET	OM	1	17.45X69.5	3.16 3.16 4.76

COMPRESSOR(压缩机)

							
编号 Number	缸径(Φ) Cylinder Diameter(Φ)	外形数据 Overall data	适用车型 Applicable models of automobiles	发动机 Generator	缸数 Number of cylinders	活塞销 Piston Pin	活塞环 Piston ring
BYPI94	94	52.30 27.00 	COMPRESSOR MERCEDES-BENZ EINBANMOTOR	OM314.OM352 OM352.OM364 OM366 .OM353	1	16.015X66	2.5 2.5 2.5
BY9500	100	70.00 36.00 	COMPRESSOR	OM	1	20X80	2.5 2.5 2.5 4
BYBF100A	100	52.20 30.40 	COMPRESSOR MERCES-BENZ.MAN. KOMPRESSOR	OM402.501LA. 502LA.541LA. 542LA. D0836.D2840. D2866.D2876. E2866	1	20X50	2.5 2.5 3
BYBF100B	100	52.20 30.40 	COMPRESSOR MERCES-BENZ.MAN. KOMPRESSOR	OM402.501LA. 502LA.541LA. 542LA. D0836.D2840. D2866.D2876. E2866	1	20X50	2.5 2.5 4
BYGT100	100	74.00 40.15 	COMPRESSOR	OM	1	20X91	2.5 2.5 4
BYCY100	100	74.00 40.15 	COMPRESSOR	OM	1	20X91	2.5 2.5 2.5 5

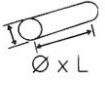
COMPRESSOR(压缩机)

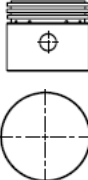
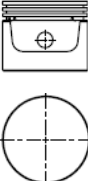
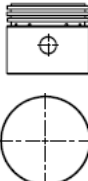

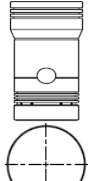
							
编号 Number	缸径(Φ) Cylinder Diameter(Φ)	外形数据 Overall data	适用车型 Applicable models of automobiles	发动机 Generator	缸数 Number of cylinders	活塞销 Piston Pin	活塞环 Piston ring
BYWP18L	100	79.00 50.00 	COMPRESSOR	OM	1	20X91	3.5 3.5 5
BYWP32L	110	90.00 50.00 	COMPRESSOR	OM	1	20X100	3.5 3.5 5
BYMC40L	136	110.00 65.00 	COMPRESSOR	OM	1	22X125	4 4 6
BYMC62L	136	100.00 60.00 	COMPRESSOR	OM	1	22X125	4 4 6
BYWP110	136	306.00 191.00 	COMPRESSOR	OM	1	40X120	4 4 4 4 4 6



RUIAN BODA PISTON CO., LTD Tel:0577-65670555 Fax:057765673555 www.bdpiston.com
 Add: No.2Floor 6Building Bailian Industrial zone Pandai Street RuiAn, Zhejiang China

按产品直径排序

Sort by Diameter

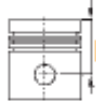
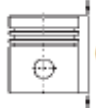
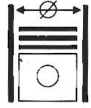

46	80.00	52.00	107	BYMC18L	COMPRESSOR
47	37.00	18.50	106	DLE61	航模
47	39.00	19.00	106	DLE120H	航模
50	80.00	52.00	107	BYMC32L	COMPRESSOR
52	53.00	21.00	106	DLE106	航模
55	38.65	26.50	107	BYCT125	COMPRESSOR
58	64.00	30.00	81	BY58RN	RENAULT
63.5	59.50	26.85	107	BYBF63.5A	COMPRESSOR
63.5	59.50	26.85	107	BYBF63.5B	COMPRESSOR
65	63.00	32.50	38	BY133F08	FIAT
65	63.00	32.50	86	BY133F08	SEAT
65	52.50	25.50	90	BY465LM	SUZUKI
65.5	55.00	24.55	103	BY465Q1	AUTO
66	54.10	23.60	103	BY465Q5	AUTO
66.7	46.05	23.85	107	BYBF66.7	COMPRESSOR
67	48.66	24.66	59	BY67KIA	KIA
67.11	41.77	23.27	95	BYSP590	VOLKSWAGEN
68.5	52.30	25.25	24	BYP1203	CHEVROLET
68.5	52.30	25.25	33	BYP1203	DAEWOO
68.5	55.00	25.00	33	BY68.5DY	DAEWOO
68.5	52.30	25.25	47	BYP1203	GENERAL MOTORS
69.7	46.00	25.95	103	BYB12D	AUTO
69.85	49.78	26.30	108	BYCI1657	COMPRESSOR
69.85	49.78	26.30	108	BYBF1657	COMPRESSOR
69.85	49.78	26.30	108	BYCI1749	COMPRESSOR
69.85	49.78	26.30	108	BYBF1749	COMPRESSOR
70	68.00	40.00	32	BY70RN	DACIA
70	68.00	40.00	34	BY70RN	DAF
70	68.00	40.00	81	BY70RN	RENAULT
70	68.00	40.00	101	BY70RN	VOLVO
70.5	47.70	25.45	24	BY1.25GM	CHEVROLET
71	62.80	32.55	59	BY1.1KIA	KIA
71	58.00	28.70	59	BY1.3KIA	KIA
72	55.00	28.00	90	BY72ZN	SUZUKI
72.5	45.00	24.00	74	BY72.5OP	OPEL
72.5	45.00	24.00	93	BY72.5OP	VAUXHALL
73	62.70	37.50	18	BY73RN	ARO
73	62.50	37.50	32	BY73RN	DACIA
73	62.50	37.50	34	BY73RN	DAF
73	72.00	39.00	69	BY73MI	MITSUBISHI
73	62.70	37.50	81	BY73RN	RENAULT
73	62.70	37.50	101	BY73RN	VOLVO
73	47.90	26.00	103	BYDK13	AUTO
73	44.80	26.20	103	BY473	AUTO

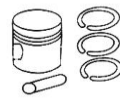
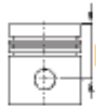
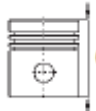
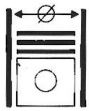

73.4	44.00	23.00	74	BY73.4POP	OPEL
73.4	46.80	25.80	74	BY73.4ROP	OPEL
74	53.90	29.40	40	BYP802	FORD
74	53.90	29.40	40	BY1.3FD	FORD
74	53.90	29.40	67	BYP802	MAZDA
74	56.10	29.10	103	BY474Q	AUTO
74.7	45.90	25.90	24	BY1.5GM	CHEVROLET
74.7	43.50	25.50	104	BYB15D	AUTO
75	64.00	40.50	30	BY1.4FK	CITROEN
75	48.93	27.75	79	BYP1413	PEUGEOT
75	64.00	40.50	79	BY1.4FK	PEUGEOT
75	46.79	23.84	83	BYRV75	ROVER
75	69.87	42.87	86	BY1.3GIF	SEAT
75	52.02	34.52	86	BY1.4GIF	SEAT
75	49.80	30.70	91	BYP2665	TOYOTA
75	69.87	42.87	95	BY1.3GIF	VOLKSWAGEN
75	52.02	34.52	95	BY1.4GIF	VOLKSWAGEN
75	57.50	27.80	108	BYBF75	COMPRESSOR
75	60.00	31.00	108	BYBF75A	COMPRESSOR
75	60.00	31.00	109	BYBF 75B	COMPRESSOR
75	52.78	32.15	109	BYBF75C	COMPRESSOR
75	60.00	31.00	109	BYRL75	COMPRESSOR
75	60.00	31.00	109	BYPI 75	COMPRESSOR
75.5	57.35	34.35	89	BY75.5SKD	SKODA
75.8	52.60	31.70	81	BY75.8RN	RENAULT
76	62.60	37.60	18	BY76RN	ARO
76	78.45	38.45	38	BY131F13	FIAT
76	77.00	38.00	60	BY1.2LD	LADA
76	77.00	38.00	60	BY2101LD	LADA
76	65.90	37.90	60	BY2108LD	LADA
76	62.35	32.50	70	BYP2599	NISSAN
76	53.60	29.35	70	BYP2610	NISSAN
76	62.60	37.60	81	BY76RN	RENAULT
76	62.60	37.60	101	BY76RN	VOLVO
76	77.00	38.00	102	BY1.2LD	ZASTAVA
76.5	47.25	28.70	19	BYP2014	AUDI
76.5	48.00	28.00.	33	BY1.5DY	DAEWOO
76.5	51.35	28.28.	33	BY76.5DY	DAEWOO
76.5	45.15	25.65	60	BY11194LD	LADA
76.5	54.00	32.00	86	BY1.6GIF	SEAT
76.5	54.00	32.00	95	BY1.6GIF	VOLKSWAGEN
76.5	47.25	28.70	95	BYP2014	VOLKSWAGEN
77	66.50	40.30	30	BY77ZN	CITROEN
77	79.20	39.70	38	BY141F652	FIAT
77	83.00	44.40	70	BY77NS	NISSAN
77	66.50	40.30	70	BY77ZN	NISSAN
77	66.50	40.30	79	BY77ZN	PEUGEOT
77	59.00	30.00	109	BYPI 77	COMPRESSOR

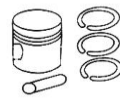
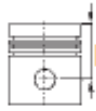
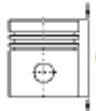
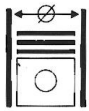

77.4	58.95	31.00	53	BY1.6ELT	HYUNDAI
77.6	52.50	32.05	24	BYP412	CHEVROLET
77.6	52.50	32.05	74	BYP412	OPEL
77.6	52.50	32.05	93	BYP412	VAUXHALL
78	65.50	30.50	70	BY2.0VG	NISSAN
78	65.50	30.50	105	BY2.0VG	红旗 小解放
78.5	50.15	32.35	79	BYP1414	PEUGEOT
79	48.40	28.00	24	BYP649	CHEVROLET
79	49.80	27.80	33	BY1.6DY	DAEWOO
79	51.70	32.20	47	BYP1027	GENERAL MOTORS
79	51.70	32.20	47	BYP1914	GENERAL MOTORS
79	77.00	38.00	60	BY1.3LD	LADA
79	77.00	38.00	60	BY21011LD	LADA
79	77.00	38.00	61	BY2105LD	LADA
79	48.40	28.00	74	BYP649	OPEL
79	48.70	28.00	74	BY79OP	OPEL
79	50.20	27.20	75	BY79AOP	OPEL
79	48.00	28.00	75	BY79BOP	OPEL
79	48.73	26.73	75	BY79POP	OPEL
79	48.70	26.70	75	BY79ROP	OPEL
79	44.50	27.45	75	BY79TOP	OPEL
79	51.70	32.20	91	BYP1914	TOYOTA
79	51.70	32.20	91	BYP1027	TOYOTA
79	48.70	28.00	93	BY79OP	VAUXHALL
79	50.20	27.20	93	BY79AOP	VAUXHALL
79	48.00	28.00	93	BY79BOP	VAUXHALL
79.5	55.00	31.70	32	BYP1200	DACIA
79.5	55.00	31.70	61	BYP1200	LADA
79.5	55.00	31.70	70	BYP1200	NISSAN
79.5	55.00	31.70	81	BYP1200	RENAULT
79.5	64.50	37.20	82	BYRN79.5LH01	RENAULT
79.5	52.85	28.33	82	BYRN79.5LH02	RENAULT
79.5	60.70	39.80	86	BYJDCY	SEAT
79.5	60.70	39.80	89	BYJDCY	SKODA
79.5	60.70	39.80	95	BYJDCY	VOLKSWAGEN
80	62.40	42.40	23	BY520BM	BMW
80	77.30	34.70	38	BY128F11	FIAT
80	45.65	22.70	63	BYRV80	LAND ROVER
80	45.65	22.70	65	BYRV80	LOTUS
80	45.65	22.70	68	BYRV80	MG
80	53.75	29.25	71	BYP1100	NISSAN
80	45.65	22.70	83	BYRV80	ROVER
80	77.30	34.70	102	BY128F11	ZASTAVA
80	64.00	31.00	109	BYBF80A	COMPRESSOR
80	49.90	26.05	110	BYBF80B	COMPRESSOR
80.5	44.90	24.20	24	BY1.8GM	CHEVROLET
80.5	45.10	24.10	38	BYP1201	FIAT
80.5	65.40	33.30	38	BY1.4FIT	FIAT

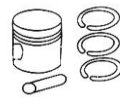
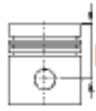
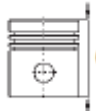
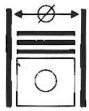

80.5	45.10	24.10	47	BYP1201	GENERAL MOTORS
80.5	44.70	24.10	47	BYP1202	GENERAL MOTORS
80.5	65.50	32.50	71	BYP615	NISSAN
80.5	45.10	24.10	75	BYP1201	OPEL
80.5	44.70	24.10	76	BYP1202	OPEL
80.5	44.70	24.10	85	BYP1202	SAAB
80.5	44.70	24.10	93	BYP1202	VAUXHALL
81	62.50	32.20	19	BYP714 STN1.8	AUDI
81	66.80	35.60	19	BY1.6NJD	AUDI
81	57.00	32.70	19	BY5VJD	AUDI
81	52.55	32.55	19	BY1.8B5	AUDI
81	53.70	32.70	19	BYP20018 AD200/1.8T	AUDI
81	53.70	32.70	20	BYP712 B5/1.8T	AUDI
81	62.30	32.20	20	BY2.2AD	AUDI
81	62.30	32.20	20	BY2.2AD	AUDI
81	53.70	32.70	20	BY1.8TA6	AUDI
81	55.00	28.80	20	BY2.4AD	AUDI
81	53.90	30.30	20	BY2.4C6	AUDI
81	70.10	44.10	82	BY81RN	RENAULT
81	62.50	32.20	86	BYP714 STN1.8	SEAT
81	53.70	32.70	87	BYP712 B5/1.8T	SEAT
81	53.70	32.70	87	BYP20018 /AD200/1.8T	SEAT
81	66.80	35.60	87	BY1.6NJD	SEAT
81	62.30	32.20	87	BY2.2AD	SEAT
81	53.70	32.70	87	BY1.8T A6	SEAT
81	57.00	32.70	89	BY5VJD	SKODA
81	53.70	32.70	89	BYP712 B5/1.8T	SKODA
81	53.70	32.70	89	BYP20018 /AD2001.8T	SKODA
81	53.70	32.70	89	BY1.8TA6	SKODA
81	62.50	32.20	96	BYP714 STN1.8	VOLKSWAGEN
81	62.50	32.20	96	BYP714 STN1.8	VOLKSWAGEN
81	64.35	38.25	96	BYP20105	VOLKSWAGEN
81	57.30	32.20	96	BYP713	VOLKSWAGEN
81	66.80	35.60	96	BY1.6NJD	VOLKSWAGEN
81	57.00	32.70	96	BY1.6BR	VOLKSWAGEN
81	53.50	32.50	97	BY1.8LSJ	VOLKSWAGEN
81	51.60	30.60	97	BY1.6L99	VOLKSWAGEN
81	53.70	32.70	97	BYP712 B5/1.8T	VOLKSWAGEN
81	53.00	32.00	97	BY2VJD	VOLKSWAGEN
81	53.50	32.50	97	BY2000STN	VOLKSWAGEN
81	57.00	32.70	97	BY5VJD	VOLKSWAGEN
81	52.55	32.55	98	BY1.8B5	VOLKSWAGEN
81	53.70	32.70	98	BY1.8TA6	VOLKSWAGEN
81	53.70	32.70	98	BYP20018 AD200/1.8T	VOLKSWAGEN
81	62.30	32.20	98	BY2.2AD	VOLKSWAGEN
81	62.30	32.20	98	BY2.2AD	VOLKSWAGEN
81	53.50	32.50	98	BY3000STN	VOLKSWAGEN
81	50.00	29.00	99	BYSTN3000G	VOLKSWAGEN

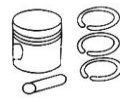
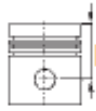
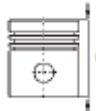
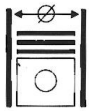

81	70.10	44.10	101	BY81RN	VOLVO
81.02	51.00	30.00	99	BYSTN3000G6	VOLKSWAGEN
81.02	59.70	38.70	99	BYSTN2000G6	VOLKSWAGEN
81.6	50.40	30.40	76	BY81.6OP	OPEL
81.6	50.40	30.40	94	BY81.6OP	VAUXHALL
82	50.47	28.47	17	BY82ALF	ALFA ROMEO
82	56.70	32.90	17	BY82BALF	ALFA ROMEO
82	56.70	32.90	39	BY82BALF	FIAT
82	62.20	32.60	40	BYP769	FORD
82	48.84	24.84	40	BYP6362 FD1.6	FORD
82	48.84	24.84	40	BYP6361	FORD
82	57.50	31.00	53	BY1.8ELT	HYUNDAI
82	65.90	37.90	61	BY21083LD	LADA
82	45.15	25.65	61	BY21116LD	LADA
82	65.90	37.90	61	BY21213LD	LADA
82	51.80	28.50	110	BYBF82A	COMPRESSOR
82	48.90	26.23	110	BYBF82B	COMPRESSOR
82.5	54.30	32.20	21	BY2.3AD	AUDI
82.5	51.79	30.90	21	BYP20019 AD2.0	AUDI
82.5	51.79	30.90	21	BY2.0NAD	AUDI
82.5	63.79	30.90	21	BY100 2.0AD	AUDI
82.5	50.50	29.60	21	BY2.0C6	AUDI
82.5	54.20	33.50	21	BY2.6A AD	AUDI
82.5	54.20	33.50	22	BY2.6BAD	AUDI
82.5	60.50	30.80	22	BYP715 AD2.8	AUDI
82.5	45.15	25.65	61	BY21126LD	LADA
82.5	51.79	30.90	87	BYP20019 AD2.0	SEAT
82.5	51.79	30.90	99	BY2.0NAD	VOLKSWAGEN
82.5	50.30	29.30	99	BYP20017 B52.0	VOLKSWAGEN
82.5	51.79	30.90	99	BYP20019 AD2.0	VOLKSWAGEN
83	56.00	32.00	17	BY83ALF	ALFA ROMEO
83	56.30	33.30	30	BY83PZ	CITROEN
83	53.90	29.90	67	BYAC8A	MAZDA
83	56.30	33.30	79	BY83PZ	PEUGEOT
84	61.00	35.00	17	BY84ALF	ALFA ROMEO
84	48.50	27.50	23	BY318BM	BMW
84	63.20	38.20	23	BY525BM	BMW
84	63.05	39.15	23	BY530BM	BMW
84	79.85	38.45	39	BY132F18	FIAT
84	77.95	38.45	39	BY132F2	FIAT
84	69.10	37.00	39	BY84PZ	FIAT
84	79.85	38.45	45	BY132F18	FSO
84	58.95	29.39	47	BYP20103	GENERAL MOTORS
84	80.00	37.00	48	BYP406	GENERAL MOTORS
84	80.0	37.00	56	BYP406	ISUZU
84	79.85	38.45	62	BY132F18	LANCIA
84	77.95	38.45	62	BY132F2	LANCIA
84	69.10	37.00	79	BY84PZ	PEUGEOT

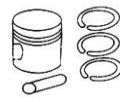
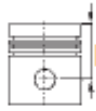
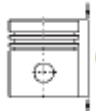
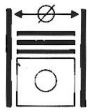

84	79.85	38.45	88	BY132F18	SEAT
84	77.95	38.45	88	BY132F2	SEAT
84	58.95	29.39	90	BYP20103	SUZUKI
84	58.95	29.39	90	BYP20103	SUZUKI
84	79.85	38.45	102	BY132F18	ZASTAVA
84.5	51.50	30.40	22	BY3.0AD	AUDI
84.5	51.50	30.40	100	BY3.0AD	VOLKSWAGEN
84.8	53.40	29.40	40	BYP822	FORD
84.8	56.60	32.60	41	BYP804	FORD
84.8	56.90	33.10	41	BYP828	FORD
84.8	53.65	33.65	76	BY84.8OP	OPEL
84.8	53.65	33.65	76	BY84.8AOP	OPEL
84.8	53.65	33.65	94	BY84.8OP	VAUXHALL
85	66.70	31.50	71	BYP2620	NISSAN
85	59.00	33.32	110	BY PI85	COMPRESSOR
85.5	82.50	39.40	100	BY85.5VW	VOLKSWAGEN
85.72	61.80	36.45	110	BYBF85.5	COMPRESSOR
86	51.50	29.60	16	BYP72010	ACURA
86	55.40	30.40	25	BYP9893 BY86OP	CHEVROLET
86	48.90	26.75	25	BYP7911	CHEVROLET
86	53.20	31.20	27	BYP3055	CHRYSLER
86	54.00	29.90	48	BYP821	GENERAL MOTORS
86	51.50	29.60	52	BYP72010	HONDA
86	48.90	26.75	76	BYP7911	OPEL
86	55.40	30.40	76	BYP9893 BY86OP	OPEL
86	55.40	30.40	77	BY86BOP	OPEL
86	55.40	30.40	94	BYP9893 BY86OP	VAUXHALL
86	55.40	30.40	94	BY86BOP	VAUXHALL
86	57.00	26.60	110	BYBF86	COMPRESSOR
86.4	65.30	33.30	39	BY202F16	FIAT
86.5	72.10	35.50	27	BYP2023	CHRYSLER
86.5	67.20	35.00	27	BYP2044	CHRYSLER
86.5	72.10	35.50	53	BYP2023	HYUNDAI
86.5	67.20	35.00	69	BYP2044	MITSUBISHI
86.5	72.10	35.50	69	BYP2023	MITSUBISHI
87	51.90	29..50	16	BYP72411	ACURA
87	80.0	37.00	48	BYP443	GENERAL MOTORS
87	67.00	32.00	55	BYP2611	INFINITI
87	80.00	37.00	56	BYP443	ISUZU
87	67.00	32.00	71	BYP2611	NISSAN
87	82.50	39.40	100	BY87VW	VOLKSWAGEN
87.1	63.00	32.50	91	BY87.1CMR	TOYOTA
87.5	56.10	34.00	27	BYP841	CHRYSLER
87.5	71.25	40.45	27	BYP219	CHRYSLER
87.5	56.00	34.50	27	BYP840	CHRYSLER
87.5	55.20	30.65	28	BYP852	CHRYSLER
87.5	56.00	34.50	35	BYP840	DODGE
87.5	56.10	34.00	35	BYP841	DODGE

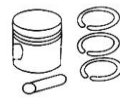
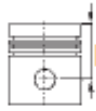
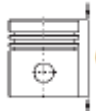
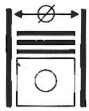

87.5	63.00	33.65	91	BYP2666	TOYOTA
87.5	71.25	40.45	105	BY488HC	红旗 小解放
87.5	71.25	40.45	105	BY488DC	红旗 小解放
87.5	56.00	34.50	105	BY488HD	红旗 小解放
87.5	56.00	34.50	105	BY488DD	红旗 小解放
88	51.47	27.50	28	BYP5242	CHRYSLER
88	71.50	37.85	30	BY88PZ	CITROEN
88	71.50	37.85	39	BY88PZ	FIAT
88	51.47	27.50	57	BYP5242	JEEP
88	71.50	37.85	80	BY88PZ	PEUGEOT
88	62.40	31.50	111	BYPI88	COMPRESSOR
88.5	55.70	35.70	91	BYP1026	TOYOTA
88.8	69.00	39.20	77	BY2.6OP	OPEL
89	72.10	42.80	23	BY730BM	BMW
89	58.95	32.95	23	BY740BM	BMW
89	57.90	37.10	25	BYP457	CHEVROLET
89	50.60	29.75	25	BYP482	CHEVROLET
89	59.90	37.80	25	BYP962	CHEVROLET
89	59.90	37.80	48	BYP962	GENERAL MOTORS
89	54.90	34.24	48	BYP426	GENERAL MOTORS
89	57.90	37.10	48	BYP457	GENERAL MOTORS
89	50.60	29.75	49	BYP482	GENERAL MOTORS
89	51.00	30.55	49	BYP485	GENERAL MOTORS
89	68.00	33.60	71	BYP2612	NISSAN
89	58.15	37.15	71	BYP2810	NISSAN
89	55.00	32.00	72	BYP2811	NISSAN
89	68.20	34.00	72	BYP2619	NISSAN
89	60.90	34.00	72	BYP2619U	NISSAN
90	51.60	29.70	25	BYP478	CHEVROLET
90	57.50	35.00	111	BYPI90B	COMPRESSOR
90	67.00	37.00	111	BYPI90	COMPRESSOR
90	59.00	35.00	111	CA112	COMPRESSOR
90.2	56.00	30.50	41	BYP787	FORD
90.2	52.00	31.00	41	BYP819	FORD
90.2	52.00	31.00	41	BYP819-10N	FORD
90.2	53.45	31.00	41	BYP819-10	FORD
90.2	51.70	30.75	42	BYP5028	FORD
90.5	72.10	39.60	100	BY90.5VW	VOLKSWAGEN
91	65.00	35.00	92	BY4YJB	TOYOTA
91.1	67.80	31.60	28	BYP249	CHRYSLER
91.1	67.80	31.60	35	BYP249	DODGE
91.1	67.80	31.60	53	BYP249	HYUNDAI
91.1	67.80	31.60	69	BYP249	MITSUBISHI
92	74.60	36.50	67	BYP2606	MAZDA
92	92.30	39.00	92	BYP9023	TOYOTA
92	74.40	39.60	100	BY92VW	VOLKSWAGEN
92	68.00	31.00	111	BYBF92	COMPRESSOR
92.08	73.30	33.55	111	BYBF92.1	COMPRESSOR

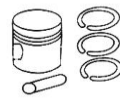
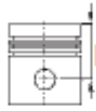
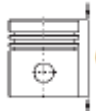
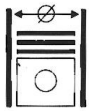

92.5	54.50	31.50	42	BY92.5FD	FORD
92.6	79.00	36.50	56	BYP2021	ISUZU
93	53.70	31.75	28	BYP225	CHRYSLER
93	53.70	31.75	35	BYP225	DODGE
93	53.70	31.75	36	BYP225	EAGLE CHRYSLER
93	50.20	28.15	49	BYP1258	GENERAL MOTORS
93	50.20	28.15	49	BYP1258	GENERAL MOTORS
93	50.20	28.15	49	BYP1258	GENERAL MOTORS
93	50.20	28.15	49	BYP1258	GENERAL MOTORS
93	50.20	28.15	56	BYP1258	ISUZU
93	53.70	31.75	69	BYP225	MITSUBISHI
93.5	77.50	38.60	42	BYP763	FORD
93.5	84.65	38.00	42	BYP716	FORD
93.67	94.00	59.50	42	BY2.5FD	FORD
94	74.40	39.60	100	BY94BWW	VOLKSWAGEN
94	52.30	27.00	112	BYP194	COMPRESSOR
95	61.00	31.50	77	BY2.4OP	OPEL
95	70.00	36.00	112	BY9500	COMPRESSOR
95.5	55.00	31.45	72	BYP13401	NISSAN
96	57.00	34.97	28	BYP3209	CHRYSLER
96	54.30	32.55	28	BYP3210	CHRYSLER
96	63.10	38.30	29	BYP847	CHRYSLER
96	54.30	32.55	35	BYP3210	DODGE
96	57.00	34.97	35	BYP3209	DODGE
96	72.20	40.08	42	BYP777	FORD
96	62.45	30.28	43	BYP816	FORD
96	62.45	30.28	67	BYP816	MAZDA
96.8	68.60	40.80	43	BYP805	FORD
96.8	61.80	36.30	43	BYP807	FORD
96.8	59.33	32.30	43	BYP814	FORD
98	52.00	31.65	55	BYP11108	INFINITI
98	58.90	31.00	72	BYP11108	NISSAN
98.4	70.30	40.42	29	BYP3241	CHRYSLER
98.4	85.50	40.30	57	BYP823	JEEP
98.4	70.30	40.42	57	BYP3241	JEEP
98.48	121.10	70.30	31	BY3.8PJS	COMMER
98.48	120.70	70.10	31	BY5.8PJS	COMMER
98.48	121.10	70.30	34	BY3.8PJS	DAF
98.48	121.10	70.30	37	BY3.8PJS	EICHER
98.48	121.10	70.30	46	BY3.8PJS	GAZ
98.48	121.10	70.30	51	BY3.8PJS	HENSCHEL
98.48	120.70	70.10	51	BY5.8PJS	HENSCHEL
98.48	120.70	70.10	54	BY3.8PJS	IMT
98.48	120.70	70.10	58	BY5.8PJS	JOHN DEERE
98.48	120.70	70.10	64	BY5.8PJS	LEYLAND
98.48	121.10	70.30	66	BY3.8PJS	MASSEY-FERGUSON
98.48	120.70	70.10	66	BY5.8PJS	MASSEY-FERGUSON
98.48	120.70	70.10	73	BY5.8PJS	OKTOBAR 14

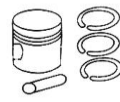
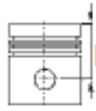
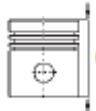
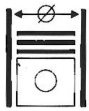

98.48	121.10	70.30	78	BY3.8PJS	PERKINS
98.48	120.70	70.10	78	BY5.8PJS	PERKINS
98.48	120.70	70.10	78	BY5.8PJS	PERKINS
98.48	120.70	70.10	84	BY3.8PJS	RVI
99.5	54.90	31.00	29	BYP1813	CHRYSLER
100	52.20	30.40	112	BYBF100A	COMPRESSOR
100	52.20	30.40	112	BYBF100B	COMPRESSOR
100	74.00	40.15	112	BYGT100	COMPRESSOR
100	74.00	40.15	112	BYCY100	COMPRESSOR
100	79.00	50.00	113	BYWP18L	COMPRESSOR
100.4	64.60	36.70	43	BYP3155	FORD
100.4	64.60	36.70	67	BYP3155	MAZDA
101.6	81.05	39.20	26	BYP567	CHEVROLET
101.6	58.00	34.00	26	BY101.6XFL	CHEVROLET
101.6	85.60	40.71	43	BYP735	FORD
102	55.60	33.50	44	BYP6620	FORD
103	92.30	53.80	50	BYP428	GENERAL MOTORS
108	66.20	34.45	50	BYP1204	GENERAL MOTORS
110	65.00	32.00	106	DLE3000	航模
110	90.00	50.00	113	BYWP32L	COMPRESSOR
136	110.00	65.00	113	BYMC40L	COMPRESSOR
136	100.00	60.00	113	BYMC62L	COMPRESSOR
136	306.00	191.00	113	BYWP110	COMPRESSOR

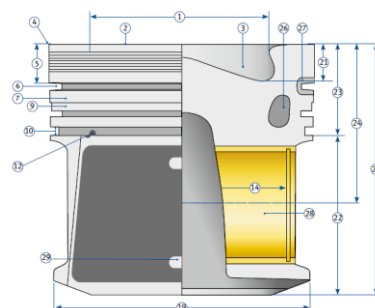
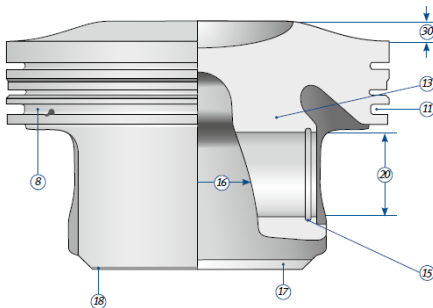

BODA PISTON



瑞安市博大活塞有限公司

RUIAN BODA PISTON CO.,LTD.

地址：浙江省瑞安市潘岱白莲工业区6幢2楼

ADD:2Floor,6Building,Bailian Industrial Zone,Pandai,Ruian,Zhejiang,China

TEL:0086-577-65670555 FAX:0086-577-65673555

<http://www.bdpiston.com> E-mail:info@bdpiston.com